

**Chirurgische Instrumente**  
*Surgical Instruments*



# INHALTSVERZEICHNIS

Warengruppe ab Seite

## **AA - MESSER**

---

Skalpellgriffe	6
Amputationsmesser	8

## **AB - SCHEREN**

---

Chirurgische Scheren	9
Präparierschere	14
Gynäkologische Scheren	17
Feine Präparierscheren	20
Tonsillenscheren	22
Nasenscheren	23
Feine chirurgische Scheren	24
Verbandscheren	25
Gipsscheren	27
Darmscheren	28
Universal Scheren	29
Standard Scheren mit Hartmetall	31
Präparierscheren mit Hartmetall	33

## **AD - PINZETTEN**

---

Anatomische Pinzetten	37
Feine Pinzetten	38
Chirurgische Pinzetten	41
Fasspinzetten	43
Atraumatische Pinzetten	44
Splitterpinzetten	45
Cilienpinzetten	46
Pinzetten mit Hartmetall	47

## **AF - NAHT INSTRUMENTE**

---

Nadelhalter	50
Nadelhalter mit Hartmetall	53
Nahtinstrumente	60
Klammerentferner	60
Unterbindungsnadeln	61
Führungshohlsonden	66

## **AH - KLEMMEN**

---

Arterienklemmen	70
Ligaturzangen	79
Peritoneumklemmen	80
Gefäßklemmen	81

## **AI - GEWEBEFASSZANGEN**

---

Gewebefaßzangen	82
-----------------	----

## **AJ - TUCHKLEMMEN**

---

Tuchklemmen	83
-------------	----

Warengruppe

ab Seite

## **AK - SCHLAUCHKLEMMEN**

---

Schlauchklemmen	84
Rollenschlauchklemmen	85

## **AL - KORNZANGEN**

---

Kornzangen	86
Kappenzangen mit Standgefäß	89

## **AM - WUNDHAKEN | SPREIZER**

---

Wundhaken	90
Wundspreizer	116
Bauchdeckenhalter	121

## **AO - GIPSINSTRUMENTE**

---

Gipsinstrumente	123
-----------------	-----

## **AP - DERMATOLOGIE | NAGEL**

---

Nagelscheren	125
Nagelzangen	127
Nagelfeile	130
Hornhautmesser	131
Komedonenquetscher	131
Kürette	132
Mamillenschneider	132
Keyes Hautstanzen	133
Fingerringsägen	134
Instrumente für Finger & Zehennägel	135

## **AR - UNTERSUCHUNGSTRUMENTE**

---

Untersuchungshammer	136
Meßinstrumente	137
Prüfinstrumente	138

## **AS - FÜHRUNGNADELN**

---

Redon Führungsnadeln	139
----------------------	-----

## **AT - STERILISATION INSTRUMENTE**

---

Sterilisation & Aufbewahrung	145
------------------------------	-----

## **BC - GYNÄKOLOGIE INSTRUMENTE**

---

Gynäkologie	147
Scheidenspekulas	149
Hegar Dilatatoren	151
Probeexzisionszangen	152
Uterus Löffel	154

## **DB - ATRAUMATISCHE GEFÄSSKLEMMEN**

---

Atraumatische Gefäßklemmen	155
----------------------------	-----

Warengruppe	ab Seite
<b>FA - OHR INSTRUMENTE</b>	
Ohrpinzetten	165
Knochenstanzen	166
<b>FB - HALS   NASE INSTRUMENTE</b>	
Nasenspekulas	167
Fomon Raspeln	170
Wundhaken	171
<b>KA - KNOCHEN INSTRUMENTE</b>	
Raspatorien	172
Knochenhebel	174
Knochenfeile	182
Raspeln	182
<b>KB - HÄMMER</b>	
Hämmer	183
<b>KC - MEISSEL   OSTEOTOME</b>	
Meißel & Osteotome	190
Mini Lexer Meißel mit Griff	192
Lexer Meißel	193
Spezial Hohlmeißel	196
Schwanenhalsmeißel	196
Klingenmeißel	197
Stille Meißel & Osteotome	198
Spongiosa Meißel	199
Hohlmeißel	200
Flachmeißel	201
Smith-Petersen Meißel	202
<b>KD - SCHARFE LÖFFEL</b>	
Scharfe Löffel	204
<b>KE - HOHLMEISSELZANGEN</b>	
Hohlmeißelzangen	208
Knochensplitterzangen	214
<b>KF - KNOCHENHALTEZANGEN</b>	
Knochenhalte-zangen	218
<b>KG - HANDBOHRFUTTER / AHLLEN</b>	
Handbohrfutter	229
Reibahlen	232
Knochenchirurgie	233
Schraubendreher	234

Warengruppe	ab Seite
Imbusschlüssel	236
Schraubenmesslehre	237
<b>KH - ORTHOPÄDIE INSTRUMENTE</b>	
Drahtspannzangen	238
Flachzangen	239
Drahtfasszangen	246
Extraktionszangen für Drähte	247
Drahtschneidezangen	248
Drahtschneidezange mit Hartmetall	249
Bolzenschneider	254
Kramponzangen Universal	257
Drahtscheren	258
Knochendraht / Cerclage Draht	259
Drähte Meßlehren	260
Biegeinstrumente	261
Drahtsägen Griff	262
Drahtumführungs-nadeln	263
Drahtspanner	265
<b>KJ - PLATTENBIEGEINSTRUMENTE</b>	
Schränkhebel	266
Plattenbiegeinstrumente	267
<b>MH - STERILISATION   AUFBEWAHRUNG</b>	
Sterilisation & Aufbewahrung	268
Nadel Sterilisierkästchen	270
<b>NR - DENTAL SAUGROHRE</b>	
Saugrohre	271

# CONTENTS

Class of Goods	from Page
<b>AA - BLADES</b>	
Scalpel Handle	6
Amputations Knife	8
<b>AB - SCISSORS</b>	
Operating Scissors	9
Dissecting Scissors	14
Gynecological Scissors	17
Fine Dissecting Scissors	20
Tonsil Scissors	22
Nasal Scissors	23
Fine Surgical Scissors	24
Bandage Scissors	25
Plaster-Of-Paris Shears	27
Enterotomy Scissors	28
Universal Bandage Scissors	29
Scissors With TC	31
Dissecting Scissors With TC	33
<b>AD - TWEEZERS</b>	
Dressing Forceps	37
Fine Tissue Forceps	38
Tissue Forceps	41
Grasping Forceps	43
Atrauma Vascular Forceps	44
Splinter Forceps	45
Cilia Forceps	46
Dissecting Forceps With TC	47
<b>AF - SUTURE INSTRUMENTS</b>	
Needle Holders	50
Needle Holders With TC	53
Suture Instruments	60
Manipulator remover	60
Ligature Needles	61
Ligature Conductors	66
<b>AH - CLAMPS</b>	
Hemostatic Forceps	70
Ligature Forceps	79
Peritoneal Clamp Forceps	80
Vessel Clamps	81
<b>AI - TISSUE SEIZING FORCEPS</b>	
Tissue Seizing Forceps	82
<b>AJ - TOWEL CLAMPS</b>	
Towel Clamps	83

Class of Goods	from Page
<b>AK - TUBING CLAMPS</b>	
Tubing Clamps	84
Tubing Clamps	85
<b>AL - DRESSING FORCEPS</b>	
Sponge And Dressing Forceps	86
Standing Vesel With Cap	89
<b>AM - RETRACTORS</b>	
Retractors	90
Self-Retaining Retractors	116
Abdominal Retractor	121
<b>AO - PLASTER CAST INSTRUMENTS</b>	
Plaster Shears	123
Plaster Cast Instruments	123
<b>AP - DERMATOLOGY   NAIL</b>	
Nail Scissors	125
Nail Cutters	127
Nail File	130
Corneal diameter	131
Comedone extractors	131
Curette	132
Mamillas tailor	132
Deraml Punches	133
Fingerring Saws	134
Instruments for Finger & Toes	135
<b>AR - CHECKUP INSTRUMENTS</b>	
Checkup Hammer	136
Scleral Markers	137
Diagnostics	138
<b>AS - GUIDE NEEDLES</b>	
Redon Guide Needles	139
<b>AT - STERILIZATION INSTRUMENTS</b>	
Sterilization & Conservation	145
<b>BC - GYNECOLOGY INSTRUMENTS</b>	
Gynecology	147
Vaginal Specula	149
Uterine Dilators	151
Cervical Biopsy And Specimen Forceps	152
Uterine Scoops	154



Class of Goods from Page

**DB - ATRAUMATISCHE VASCULAR CLAMP**  
Atraumatic Vascular Clamp 155

**FA - EAR INSTRUMENTS**  
Ear Forceps 165  
Bone Cutting Forceps 166

**FB - THROAT | NOSE INSTRUMENTS**  
Nasal Specula 167  
Fomon Rasps 170  
Retractors 171

**KA - BONE INSTRUMENTS**  
Raspatories 172  
Bone Levers 174  
Bone Files 182  
Rasps 182

**KB - MALLETS**  
Mallets 183

**KC - CHISELS | GOUGES**  
Chisels & Gouges 190  
Mini Gouges With Handle 192  
Osteotomes 193  
Osteotomes 196  
Gouges 196  
Chisels & Gouges 197  
Stille Chisels & Gouges 198  
Chisles 199

**KD - BONE CURETTES**  
Bone Curettes 204

**KE - GOUGE FORCEPS**  
Bone Rongeurs 208  
Bone Cutting Forceps 214

**KF - BONE HOLDING FORCEPS**  
Bone Holding Forceps 218

**KG - DRILLING CHUCKS / REAMERS**  
Drilling Chucks 229  
Reamers 232  
Bone Surgery 233

Class of Goods from Page

Screw Driver 234  
Bus key 236  
Measuring Instruments 237

**KH ORTHOPEDICS INSTRUMENTS**  
Wire Twister 238  
Flat Nose Pliers 239  
Wire Holding Forceps 246  
Wire Pullers Forceps 247  
Wire Cutters 248  
Wire Cutters With TC 249  
Pin Cutters 254  
Krampon Forceps 257  
Wire Cutting Scissors 258  
Soft Wires / Cerclage wire 259  
Wires Gauging Tools 260  
Bending Instruments 261  
Wire Saws handle 262  
Cerclage Instruments 263  
Wire Tighening Instruments 265

**KJ - BENDING IRONS FOR BONE PLATES**  
Bending Irons For Bone Plates 266  
Forceps For Plattes Bending Press 267

**MH - STERILIZATION | CONSERVATION**  
Sterilization & Conservation 268

**NR - DENTAL SUCTION TUBES**  
Suction Tubes 271

**SKALPELLGRIFFE**  
**SCALPEL HANDLE**

MANGOS DE BISTUTÍES  
MANCHES POUR BISTOURIS  
MANICI PER BISTURI

AA



Skalpells Griff Nr. 3

AA.200.03



Skalpells Griff Nr. 4

AA.200.04



Skalpells Griff Nr. 3

AA.201.03



Skalpells Griff Nr. 3

AA.204.03



Skalpells Griff Nr. 3SL

AA.204.33



Skalpells Griff Nr. 4

AA.204.04



Skalpell  
Griff Nr. 7

AA.206.07



Skalpell  
Griff Nr. 7

AA.206.17

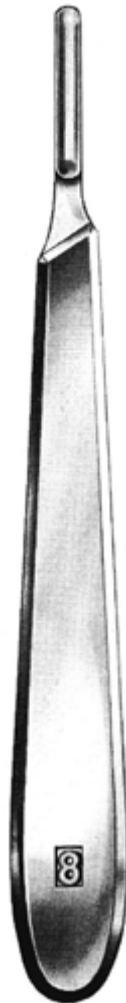

Skalpell  
Griff Nr. 8

AA.208.08



Skalpellgriff  
für Mikroklingen

AA.208.48

**AMPUTATIONSMESSER**  
**AMPUTATIONS KNIFE**

COUTEAUX À AMPUTATION  
CUCHILLOS PARA AMPUTAZIONE  
COLTELLI PER AMPUTAZIONE

AA



**Amputationsmesser**

Article No.	Cut length
AA.300.13	13,0cm
AA.300.16	16,0cm
AA.300.19	19,0cm
AA.300.22	22,0cm
AA.300.28	28,0cm

**Catlin**

Article No.	Cut length
AA.306.11	13,0cm
AA.306.16	16,0cm
AA.306.19	19,0cm
AA.306.22	22,0cm

**Liston**

AA.310.17	17,0cm
-----------	--------

**Langenbeck**

AA.315.12	12,0cm
-----------	--------

**Phalangenmesser**  
*Phalangenknife*

AA.316.09	9,0cm
-----------	-------



Article No.	Size
AB.100.13	13,0cm
AB.100.14	14,5cm
AB.100.16	16,5cm
AB.100.18	18,5cm

Stumpf / Stumpf  
*Blunt / Blunt*

Smusse / Smusse  
Romas / Romas  
Mousses / Mousses



Article No.	Size
AB.101.13	13,0cm
AB.101.14	14,5cm
AB.101.16	16,5cm
AB.101.18	18,5cm



Article No.	Size
AB.102.13	13,0cm
AB.102.14	14,5cm
AB.102.16	16,5cm
AB.102.18	18,5cm

Spitz/ Stumpf  
*Sharp / Blunt*



Article No.	Size
AB.103.13	13,0cm
AB.103.14	14,5cm
AB.103.16	16,5cm
AB.103.18	18,5cm



Article No.	Size
AB.104.13	13,0cm
AB.104.14	14,5cm
AB.104.16	16,5cm
AB.104.18	18,5cm

Spitz/ Spitz  
*Sharp / Sharp*



Article No.	Size
AB.105.13	13,0cm
AB.105.14	14,5cm
AB.105.16	16,5cm
AB.105.18	18,5cm

# CHIRURGISCHE SCHEREN OPERATING SCISSORS

TIJERAS PARA CIRUGIA  
CISEAUX À CHIRURGIE  
FORBICI PER CHIRURGIA

AB



## Chirurgische Schere

Article No.	Size
AB.100.44	14,5cm

Für Linkshänder  
*for left handers*

Para Zurdos  
Pour les gauchers  
Per mancini

Stumpf / Stumpf  
*Blunt / Blunt*

Smusse / Smusse  
Romas / Romas  
Mousses / Mousses



## Chirurgische Schere

Article No.	Size
AB.101.44	14,5cm

Für Linkshänder  
*for left handers*

Para Zurdos  
Pour les gauchers  
Per mancini



Article No.	Size
AB.102.44	14,5cm

Für Linkshänder  
*for left handers*

Para Zurdos  
Pour les gauchers  
Per mancini

Spitz / Stumpf  
*Pointed / Blunt*

Acute / Smusse  
Agudas / Romas  
Pointus / Mousses



Article No.	Size
AB.103.44	14,5cm

Für Linkshänder  
*for left handers*

Para Zurdos  
Pour les gauchers  
Per mancini



Article No.	Size
AB.104.44	14,5cm

Für Linkshänder  
*for left handers*

Para Zurdos  
Pour les gauchers  
Per mancini

Spitz / Spitz  
*pointed / pointed*

Acute / Acute  
Agudas / Agudas  
Pointus / Pointus



Article No.	Size
AB.105.44	14,5cm

Für Linkshänder  
*for left handers*

Para Zurdos  
Pour les gauchers  
Per mancini





Grazil

Article No.	Size
AB.110.13	13,0cm
AB.110.14	14,5cm

Stumpf / Stumpf  
*Blunt / Blunt*

Smusse / Smusse  
Romas / Romas  
Mousses / Mousses



Grazil

Article No.	Size
AB.111.13	13,0cm
AB.111.14	14,5cm



Grazil

Article No.	Size
AB.112.13	13,0cm
AB.112.14	14,5cm

Spitz / Stumpf  
*Pointed / Blunt*

Acute / Smusse  
Agudas / Romas  
Pointus / Mousses



Grazil

Article No.	Size
AB.113.13	13,0cm
AB.113.14	14,5cm



Grazil

Article No.	Size
AB.114.13	13,0cm
AB.114.14	14,5cm

Spitz / Spitz  
*pointed / pointed*

Acute / Acute  
Agudas / Agudas  
Pointus / Pointus



Grazil

Article No.	Size
AB.115.13	13,0cm
AB.115.14	14,5cm

**CHIRURGISCHE SCHEREN**  
**OPERATING SCISSORS**

TIJERAS PARA CIRUGIA  
CISEAUX À CHIRURGIE  
FORBICI PER CHIRURGIA

AB

gerade  
straight

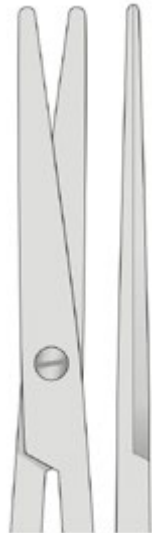

15,0cm  
AB.144.15



17,0cm  
AB.144.17



19,5cm  
AB.144.19

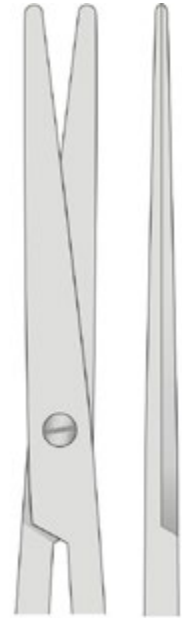

21,0cm  
AB.144.21



Mayo-Style Schere

gebogen  
curved

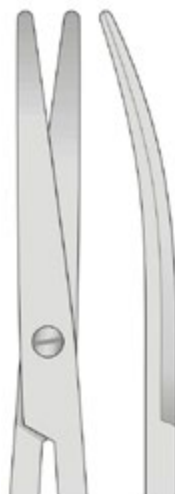

15,0cm  
AB.145.15

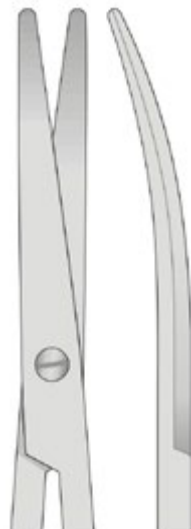

17,0cm  
AB.145.17



19,5cm  
AB.145.19

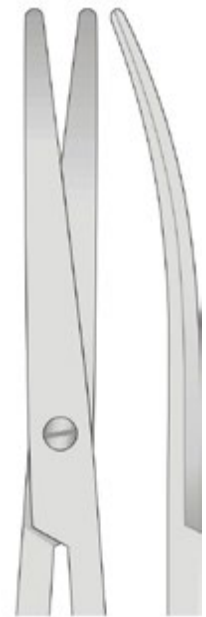

21,0cm  
AB.145.21

**AB**



Sanvenero Schere

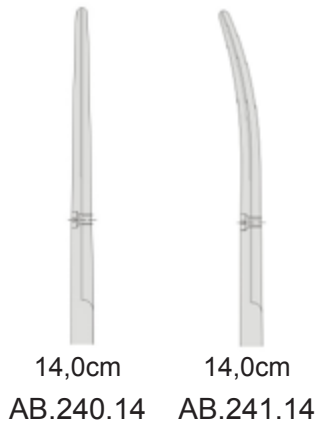

14,0cm

AB.240.14

14,0cm

AB.241.14



Joseph Schere



14,0cm

AB.244.14

14,0cm

AB.245.14



Satinsky Gefäßschere

Article No.

AB.293.24

Size

24,5cm



Strully Schere

Article No.

AB.333.22

Size

22,0cm

# PRÄPARIERSCHEREN DISSECTING SCISSORS

TIJERAS PARA PREPARACIONES  
CISEAUX À DISSECTION  
FOBICI PER DISSEZIONE

AB

Stumpf  
*Blunt*  
Smusse  
Romas  
Mousses



Metzenbaumschere

Stumpf  
*Blunt*  
Smusse  
Romas  
Mousses



Article No.	Size
AB.200.14	14,5cm
AB.200.18	18,0cm
AB.200.20	20,0cm
AB.200.23	23,0cm
AB.200.25	25,0cm
AB.200.28	28,0cm
AB.200.30	30,0cm

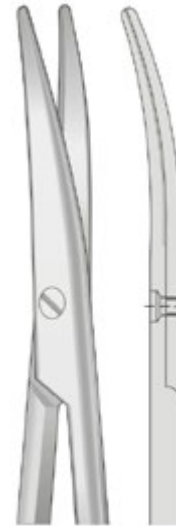

Article No.	Size
AB.201.14	14,5cm
AB.201.18	18,0cm
AB.201.20	20,0cm
AB.201.23	23,0cm
AB.201.25	25,0cm
AB.201.28	28,0cm
AB.201.30	30,0cm

AB



Lexer Schere



16,0cm  
AB.210.16



21,0cm  
AB.210.21



16,0cm  
AB.211.16

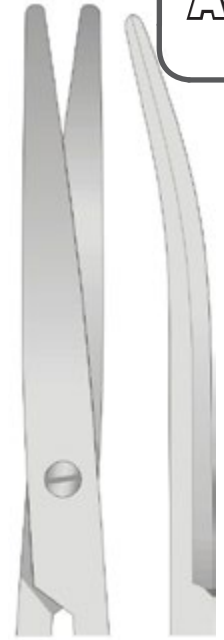

21,0cm  
AB.211.21



Lexer - Fino Schere

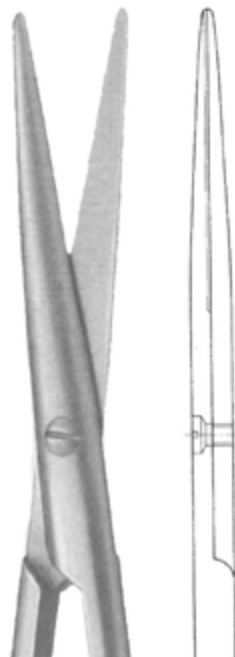

16,0cm  
AB.212.16

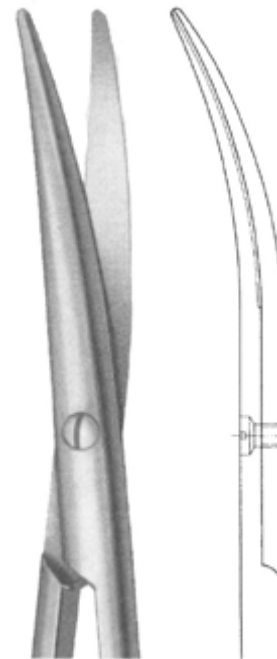

16,0cm  
AB.213.16

**PRÄPARIERSCHEREN**  
**DISSECTING SCISSORS**

TIJERAS PARA PREPARACIONES  
CISEAUX À DISSECTION  
FOBICI PER DISSEZIONE

AB



Metzenbaum - Lahey  
Schere



15,0cm  
AB.198.15



15,0cm  
AB.199.15



Article No.	Size
AB.230.14	14,5cm
AB.230.18	18,0cm
AB.230.20	20,0cm
AB.230.23	23,0cm



Article No.	Size
AB.231.14	14,5cm
AB.231.18	18,0cm
AB.231.20	20,0cm
AB.231.23	23,0cm

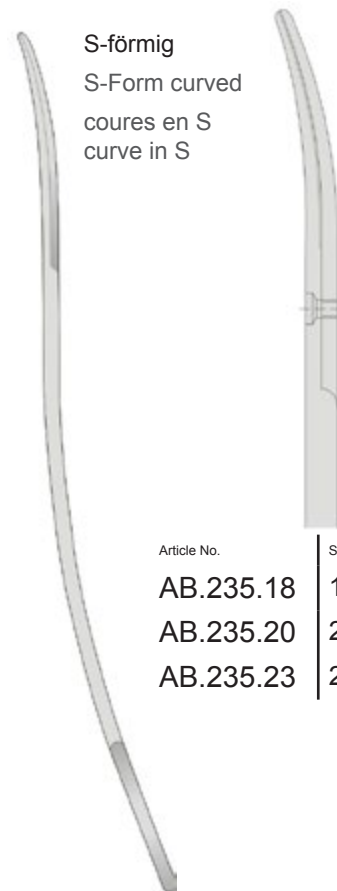

S-förmig  
S-Form curved  
cours en S  
curve in S

Article No.	Size
AB.235.18	18,0cm
AB.235.20	20,0cm
AB.235.23	23,0cm



Metzenbaum - Fino  
Schere





14,5cm  
AB.153.14



19,5cm  
AB.153.19



22,5cm  
AB.153.22

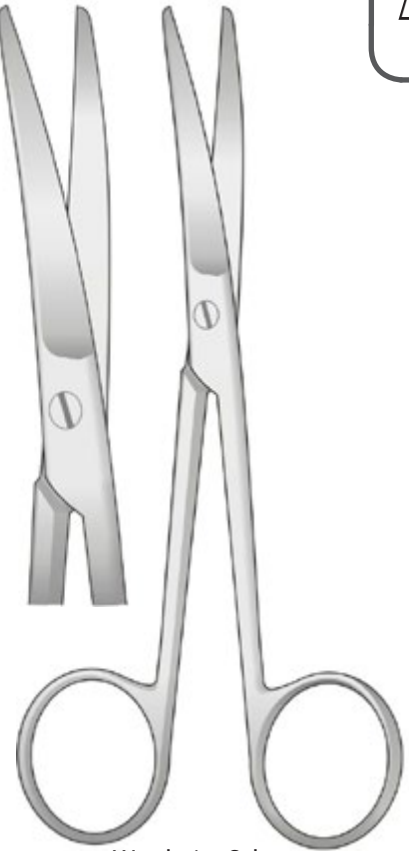

Wertheim Schere



Dubois Schere



27,0cm  
AB.154.27



27,0cm  
AB.155.27

**GYNÄKOLOGISCHE SCHEREN**  
**GYNECOLOGICAL SCISSORS**

TIJERAS PARA GINECOLOGIA  
CISEAUX À GYNÉCOLOGIE  
FOBICI GINECOLOGIA

**AB**



20,0cm  
AB.160.20

Sims



20,0cm  
AB.161.20



23,0cm  
AB.160.23

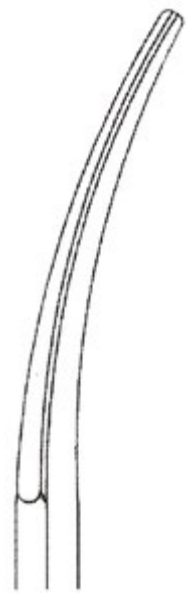

23,0cm  
AB.161.23



20,0cm  
AB.162.20

Sims



20,0cm  
AB.163.20



23,0cm  
AB.162.23



23,0cm  
AB.163.23

**AB**



**Dammschere**

Article No.	Size
AB.392.24	24,0cm



18,0cm  
 AB.395.18



20,0cm  
 AB.397.20



**Busch**

13,0cm  
 AB.405.13

16,0cm  
 AB.405.16



**Braun-Stadler**

Article No.	Size
AB.400.22	22,0cm



14,0cm  
 AB.400.14

20,0cm  
 AB.400.20

**FEINE PRÄPARIERSCHEREN**  
**FINE DISSECTING SCISSORS**

TIJERAS FINAS PARA PREPARACIONES  
 CISEAUX FINS À DISSECTION  
 FORBICI FINE PER CHIRURGIA

AB

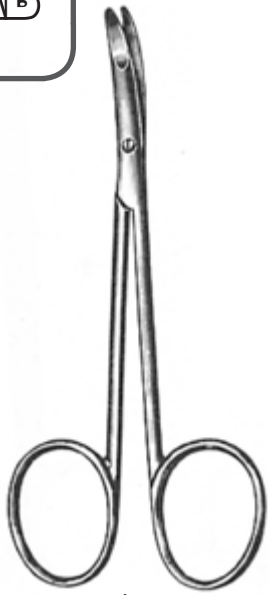

Kilner

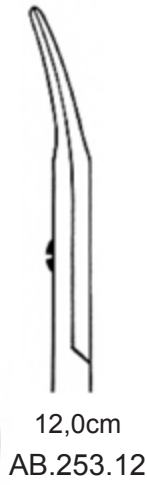

12,0cm  
 AB.253.12



15,0cm  
 AB.253.15



Goldmann-Fox



12,0cm  
 AB.268.12

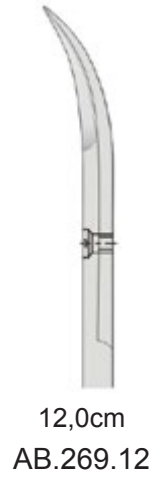

12,0cm  
 AB.269.12

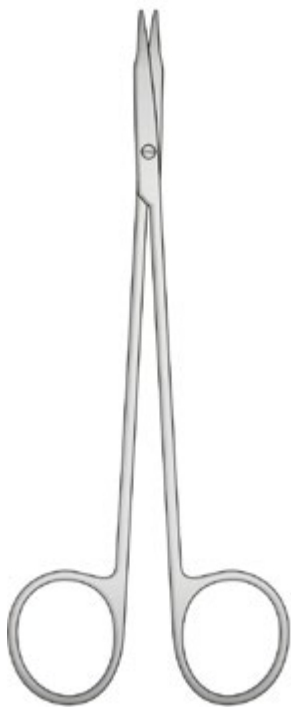

Reynolds



15,0cm  
 AB.260.15



15,0cm  
 AB.261.15

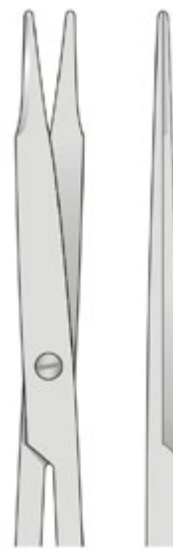

18,0cm  
 AB.260.18



18,0cm  
 AB.261.18



Stevens



11,5cm  
AB.480.11



11,5cm  
AB.481.11



11,5cm  
AB.482.11



11,5cm  
AB.483.11



Metzenbaum



10,5cm  
AB.484.11



10,5cm  
AB.485.11



MEDE Spezial



11,0cm  
AB.494.11



11,0cm  
AB.495.11

**TONSILLENSCHEREN**  
**TONSIL SCISSORS**

TIJERAS PARA AMIGDALAS  
CISEAUX POUR LES AMYGDALES  
FORBICI PER TONSILLE

AB



Schmieden-Taylor

Article No.	Size
AB.337.17	17,0cm

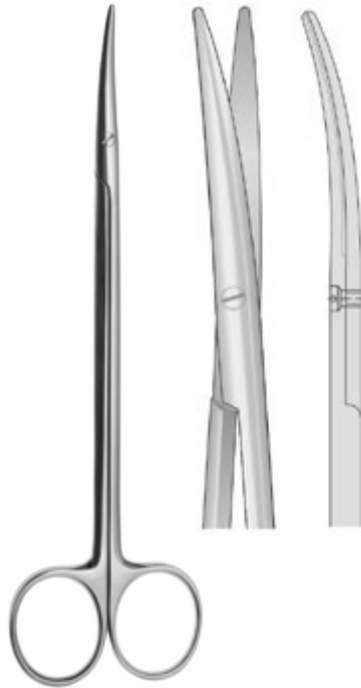

Toennis-Adson

Article No.	Size
AB.339.17	17,5cm



Böttcher

Article No.	Size
AB.352.18	18,0cm

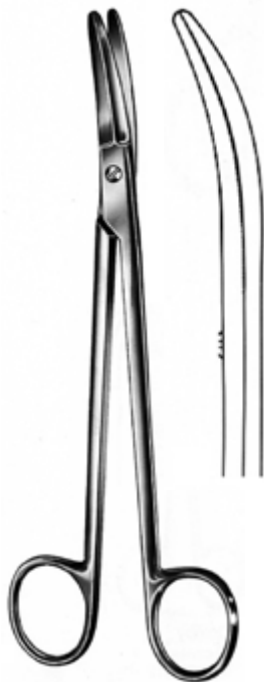

Prince

Article No.	Size
AB.353.17	17,5cm



Good

Article No.	Size
AB.355.19	19,0cm



Oicevrona

Article No.	Size
AB.360.23	23,0cm





**Fomon**

Article No.	Size
AB.381.15	15,0cm



**Cottle**

Article No.	Size
AB.383.16	16,0cm



**Heyma**

Article No.	Size
AB.385.18	18,0cm



**Heyma-Knight**

Article No.	Size
AB.386.18	17,5cm

**FEINE CHIRURGISCHE SCHEREN**  
**FINE SURGICAL SCISSORS**

TIJERAS FINAS PARA CIRUGIA  
 CISEAUX FINS CHIRURGICAUX  
 FORBICI FINE PER CHIRURGIA

**AB**



Feine Schere



9,0cm  
 AB.444.08



8,5cm  
 AB.445.08

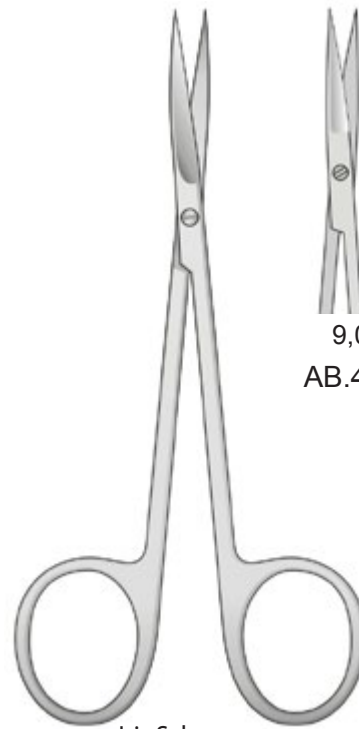

Iris Schere



9,0 cm  
 AB.450.09



9,5cm  
 AB.451.09



Iris Schere



10,5cm  
 AB.450.10



10,5cm  
 AB.451.10



Iris Schere



11,5cm  
 AB.450.11



11,5cm  
 AB.451.11



Lister Schere

Article No.	Size
AB.610.09	9,0cm
AB.610.11	11,0cm
AB.610.14	14,0cm
AB.610.16	16,0cm
AB.610.18	18,0cm
AB.610.20	20,0cm



Lister Verbandschere  
 großer Ring

Article No.	Size
AB.611.20	20,0cm



Lister Verbandsschere

Article No.	Size
AB.614.14	14,0cm
AB.614.18	18,0cm
AB.614.20	20,0cm



Esmarch

Article No.	Size
AB.625.20	20,0cm
AB.625.22	22,0cm



**VERBANDSCHEREN**  
**BANDAGE SCISSORS**

TIJERAS PARA VENDAJES  
CISEAUX POUR PANSEMENTS  
FORBICI PER BENDAGGI

AB



Lister Schere

Article No.	Size
AB.613.14	14,5cm
AB.613.18	18,0cm
AB.613.20	20,0cm

Schere mit Hartmetall  
*Scissor with Tungsten Carbide*

Tijeras con inseraciones tungsteno varbit  
Ciseaux avec en carbure tungstène  
Forbici con carburo di tungsteno

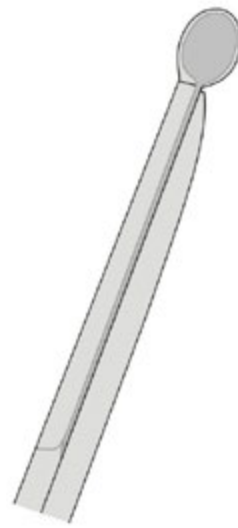

Mikrotomschliff  
*Microtom Grinding*  
Affûtage

Lister Schere

Article No.	Size
AB.710.14	14,5cm
AB.710.18	18,0cm
AB.710.20	20,0cm





Burns



24,0cm  
**AB.636.24**  
 Gezahnte Schneide  
*Blade serrated*  
 Hoja dentada  
 Lame dentelée  
 Filo dentellato



24,0cm  
**AB.895.24**  
 Mit Hartmetallschneide  
*With Tungsten Carbide*  
 Con inserciones de tungsteno  
 les mâchoires en tungsténo  
 Con taglio in carburo di tungsteno



Glatt  
*Smooth*  
 Lisas  
 Lisses  
 liscie

Burns Gipsschere ungezähnt

Article No.	Size
AB.634.20	20,0cm
AB.634.24	24,0cm



Burns Gipsschere

Article No.	Size
AB.635.20	20,0cm

## DARMSCHEREN ENTERETOMY SCISSORS

TIJERAS ENTERÓTOMOS  
CISEAUX-ENTÉROTOMES  
FORBICI PER ENTEROTOMIA

AB

Darmschere  
*Enterotomy  
Scissor*

Tijeras enterótomos  
Ciseaux-entérotomes  
Forbici per enterotomia



Darmschere



21,0cm  
AB.510.21



21,0cm  
AB.514.21





Universal Schere blau

Article No.	Size
AB.657.06	14,0cm



Universal Schere pink

Article No.	Size
AB.657.09	14,0cm



Universal Schwestern-  
schere

Article No.	Size
AB.660.14	14,0cm

# UNIVERSALSCHEREN UNIVERSAL BANDAGE SCISSORS

TIJERAS PARA VENDAJES  
CISEAUX POUR PANSEMENTS  
FORBICI PER BENDAGGI

AB



AB.650.02



AB.650.03



AB.650.04



AB.650.05



AB.650.06

Universal Schere  
*Universal Bandage Scissor*

Tijeras para vendajes  
Ciseaux pour pansements  
Forbici per bendaggi



Universal Schere

Article No.	Size
AB.650.01	14,0cm



Mit  
Plastikschutzkappe

Universal Schere schwarz

Article No.	Size
AB.650.11	14,0cm



AB.655.02



AB.655.03



AB.655.04



AB.655.05



AB.655.06



Universal Schere

Article No.	Size
AB.655.01	18,0cm



Mit  
Plastikschutzkappe



AB.655.15

Universal Schere

Article No.	Size
AB.655.11	18,0cm

TIJARAS CON INSERCIONES CARBURO DE TUNGSTENO  
 CISEAUX AVEC PLAQUETTES EN CARBURE DE TUNGSTÈNE  
 FORBICI CON TAGLIO IN CARBURO DI TUNGSTENO

**STANDARD SCHEREN MIT HM**  
**SCISSORS WITH TC**

AB



Standard

Article No.	Size
AB.800.13	13,0cm
AB.800.14	14,5cm
AB.800.16	16,5cm
AB.800.18	18,5cm



Standard

Article No.	Size
AB.801.13	13,0cm
AB.801.14	14,5cm
AB.801.16	16,5cm



Standard

Article No.	Size
AB.802.13	13,0cm
AB.802.14	14,5cm
AB.802.16	16,5cm
AB.802.18	18,5cm



Standard

Article No.	Size
AB.803.13	13,0cm
AB.803.14	14,5cm
AB.803.16	16,5cm

**STANDARD SCHEREN MIT HM**  
**SCISSORS WITH TC**

TIJARAS CON INSERCIONES CARBURO DE TUNGSTENO  
 CISEAUX AVEC PLAQUETTES EN CARBURE DE TUNGSTÈNE  
 FORBICI CON TAGLIO IN CARBURO DI TUNGSTENO

AB



Standard

Article No.	Size
AB.804.13	13,0cm
AB.804.14	14,0cm
AB.804.16	16,0cm
AB.804.18	18,0cm



Standard

Article No.	Size
AB.805.13	13,0cm
AB.805.14	14,0cm
AB.805.16	16,0cm



TIJARAS DE DISECCIÓN CON INSERCIONES CARBURO DE TUNGSTENO  
 CISEAUX À DISSECTION AVEC PLAQUETTES EN CARBURE DE TUNGSTÈNE  
 FORBICI CON TAGLIO IN CARBURO DI TUNGSTENO

**PRÄPARIERSCHEREN MIT HM**  
**DISSECTING SCISSORS WITH TC**

**AB**



Mayo

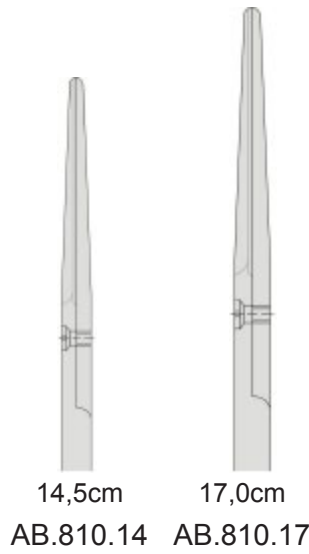

14,5cm AB.810.14 17,0cm AB.810.17



Mayo

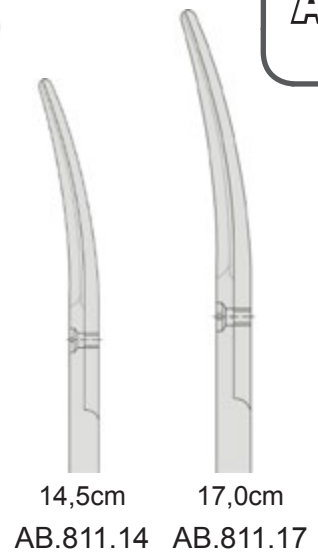

14,5cm AB.811.14 17,0cm AB.811.17



Mayo-Stille

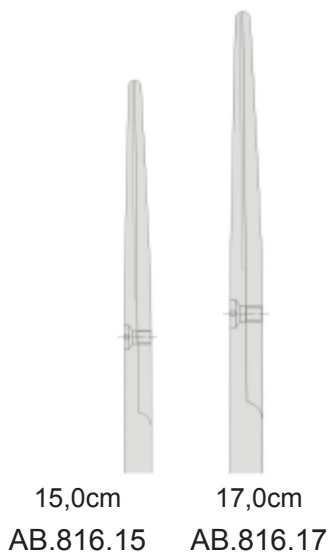

15,0cm AB.816.15 17,0cm AB.816.17



Mayo-Stille

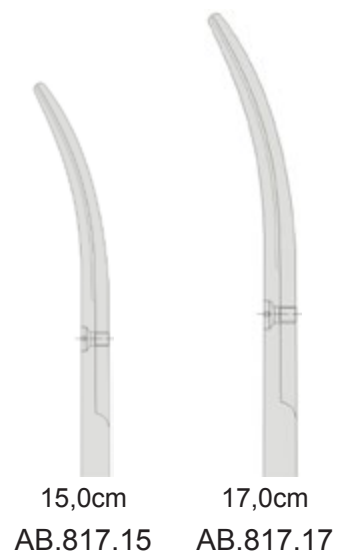

15,0cm AB.817.15 17,0cm AB.817.17

# PRÄPARIERSCHEREN MIT HM DISSECTING SCISSORS WITH TC

TIJARAS DE DISECCIÓN CON INSERCIONES CARBURO DE TUNGSTENO  
CISEAUX À DISSECTION AVEC PLAQUETTES EN CARBURE DE TUNGSTÈNE  
FORBICI CON TAGLIO IN CARBURO DI TUNGSTENO

AB

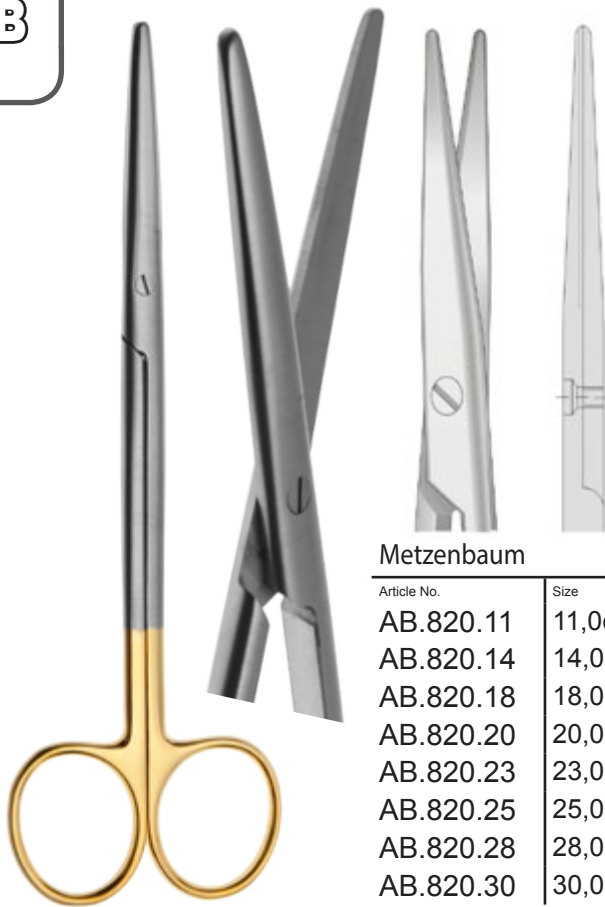

Stumpf / Stumpf  
Blunt / Blunt  
Smusse / Smusse  
Romas / Romas  
Mousses / Mousses

## Metzenbaum

Article No.	Size
AB.820.11	11,0cm
AB.820.14	14,0cm
AB.820.18	18,0cm
AB.820.20	20,0cm
AB.820.23	23,0cm
AB.820.25	25,0cm
AB.820.28	28,0cm
AB.820.30	30,0cm

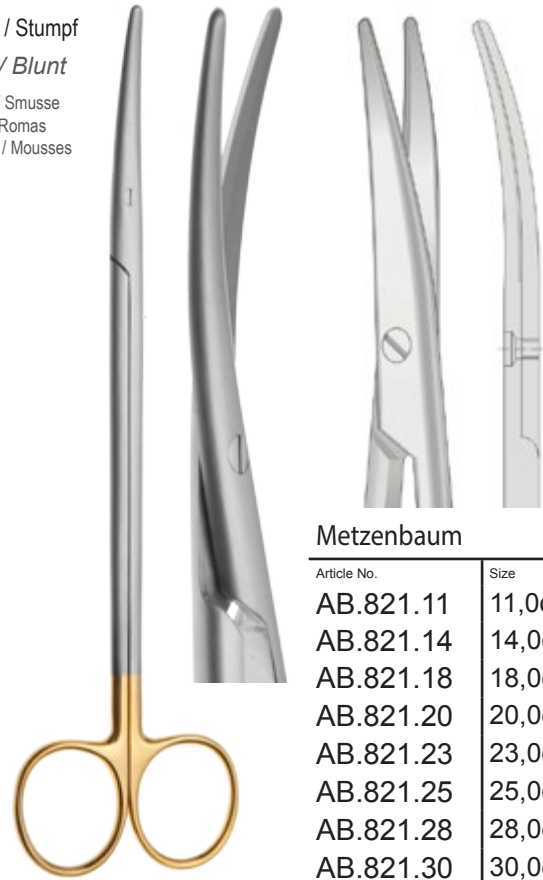

## Metzenbaum

Article No.	Size
AB.821.11	11,0cm
AB.821.14	14,0cm
AB.821.18	18,0cm
AB.821.20	20,0cm
AB.821.23	23,0cm
AB.821.25	25,0cm
AB.821.28	28,0cm
AB.821.30	30,0cm



## Metzenbaum - Fino

Article No.	Size
AB.822.14	14,0cm
AB.822.18	18,0cm
AB.822.20	20,0cm
AB.822.23	23,0cm
AB.822.25	25,0cm
AB.822.28	28,0cm

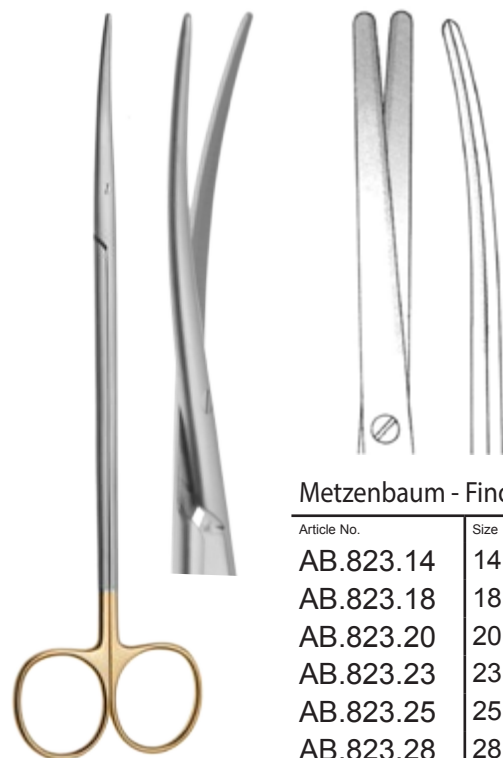

## Metzenbaum - Fino

Article No.	Size
AB.823.14	14,0cm
AB.823.18	18,0cm
AB.823.20	20,0cm
AB.823.23	23,0cm
AB.823.25	25,0cm
AB.823.28	28,0cm

TIJARAS DE DISECCIÓN CON INSERCIONES CARBURO DE TUNGSTENO  
 CISEAUX À DISSECTION AVEC PLAQUETTES EN CARBURE DE TUNGSTÈNE  
 FORBICI CON TAGLIO IN CARBURO DI TUNGSTENO

## PRÄPARIERSCHEREN MIT HM DISSECTING SCISSORS WITH TC

AB



Spitz  
 Sharp  
 Acute  
 Agudas  
 Pointus



Metzenbaum-Fino

Article No.	Size
AB.824.14	14,0cm
AB.824.18	18,0cm



Metzenbaum-Fino

Article No.	Size
AB.825.14	14,0cm
AB.825.18	18,0cm



Metzenbaum S-Form

Article No.	Size
AB.827.18	18,0cm
AB.827.20	20,0cm
AB.827.23	23,0cm

**PRÄPARIERSCHEREN MIT HM**  
**DISSECTING SCISSORS WITH TC**

TIJARAS DE DISECCIÓN CON INSERCIONES CARBURO DE TUNGSTENO  
 CISEAUX À DISSECTION AVEC PLAQUETTES EN CARBURE DE TUNGSTÈNE  
 FORBICI CON TAGLIO IN CARBURO DI TUNGSTENO

AB



Toennis-Adson



17,5cm  
 AB.829.17



Lexer-Fino



16,0cm  
 AB.830.16



16,0m  
 AB.831.16



Lexer

Article No.	Size
AB.832.16	16,0cm
AB.832.21	21,0cm



Lexer

Article No.	Size
AB.833.16	16,0cm
AB.833.21	21,0cm





Anatomische Pinzette

Article No.	Size
AD.100.10	10,0cm
AD.100.11	11,5cm
AD.100.13	13,0cm
AD.100.14	14,5cm
AD.100.16	16,0cm
AD.100.18	18,0cm
AD.100.20	20,0cm
AD.100.25	25,0cm
AD.100.30	30,0cm
AD.100.45	45,0cm
AD.100.60	60,0cm

Schmal  
 Small  
 Pequeno  
 Petit  
 Piccolo



Anatomische schmal

Article No.	Size
AD.102.13	13,0cm
AD.102.14	14,5cm
AD.102.16	16,0cm
AD.102.18	18,0cm
AD.102.20	20,0cm
AD.102.25	25,0cm
AD.102.30	30,0cm

Fein  
 Delicate  
 Finas  
 Délicates  
 Fine



14,5cm  
 AD.106.14

**FEINE PINZETTEN**  
**FINE TISSUE FORCEPS**

PINZAS DE DISECCIÓN CON DIENTES FINAS  
PINCES MODÈLES FINS  
PINZE MODELLI FINI

AD



Semken

Article No.	Size
AD.134.12	12,0cm



Semken

Article No.	Size
AD.134.15	15,0cm



Semken

Article No.	Size
AD.135.12	12,0cm



Semken

Article No.	Size
AD.370.12	12,0cm
AD.370.15	15,0cm



Semken

Article No.	Size
AD.371.12	12,0cm

PINZAS DE DISECCIÓN CON DIENTES FINAS  
 PINCES MODÈLES FINS  
 PINZE MODELLI FINI

**FEINE PINZETTEN**  
**FINE TISSUE FORCEPS**

AD



Cushing



Potts-Smith

Article No.	Size
AD.170.18	18,0cm
AD.170.21	21,0cm
AD.170.25	25,0cm

**FEINE PINZETTEN**  
**FINE TISSUE FORCEPS**

PINZAS DE DISECCIÓN CON DIENTES FINAS  
PINCES MODÈLES FINS  
PINZE MODELLI FINI

AD



Graefe-Iris

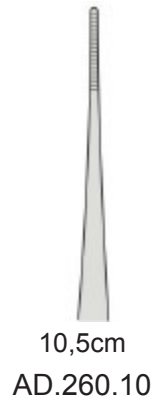

Graefe-Iris





Chirurgische Pinzette 1x2

Article No.	Size
AD.300.10	10,5cm
AD.300.13	13,0cm
AD.300.14	14,5cm
AD.300.16	16,0cm
AD.300.18	18,0cm
AD.300.20	20,0cm
AD.300.25	25,0cm
AD.300.30	30,0cm



Chir. Pinzette schlank 1x2

Article No.	Size
AD.302.11	11,0cm
AD.302.13	13,0cm
AD.302.14	14,5cm
AD.302.16	16,0cm
AD.302.18	18,0cm
AD.302.20	20,0cm
AD.302.25	25,0cm
AD.302.30	30,0cm



Chir. Pinzette fein 1x2

Article No.	Size
AD.304.14	14,5cm
AD.304.16	16,0cm

# CHIRURGISCHE PINZETTEN TISSUE FORCEPS

PINZAS QUIRÚRGICAS  
PINCES À DISSECTION À GRIFFES  
PINZE CHIRURGICHA A DENTI DI TOPO

AD



2x3 Zähne



Article No.	Size
AD.306.13	13,0cm
AD.306.14	14,5cm
AD.306.16	16,0cm
AD.306.18	18,0cm
AD.306.20	20,0cm



3x4 Zähne



Article No.	Size
AD.308.13	13,0cm
AD.308.14	14,5cm
AD.308.16	16,0cm



4x5 Zähne



Article No.	Size
AD.310.14	14,5cm
AD.310.16	16,0cm

PINZAS PARA COGER  
 PINCES POUR SAISIR LES TISSUS  
 PINZE PER AFFERRARE TESSUTI

**FASSPINZETTEN**  
**GRASPING FORCEPS**

AD



**Russ. Modell**

Article No.	Size
AD.470.15	15,0cm
AD.470.20	20,0cm
AD.470.25	25,0cm



Desmarres



9,0cm  
 AD.744.01



9,0cm  
 AD.744.02



9,0cm  
 AD.744.03

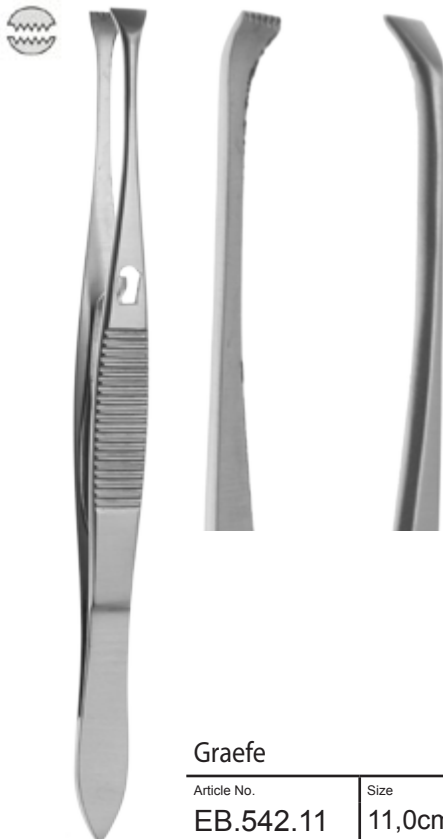

**Graefe**

Article No.	Size
EB.542.11	11,0cm



**Cottle**

Article No.	Size
FB.126.10	10,0cm



# ATRAUMATISCHE PINZETTEN ATRAUMA VASCULAR FORCEPS

ATRAUMA PINZAS VASCULARES  
PINCES ATRAUMATIQUES  
PINZE ATRAUMA

AD



De Bakey 2,0mm

Article No.	Size
AD.602.16	16,0cm
AD.602.20	20,0cm
AD.602.24	24,0cm
AD.602.30	30,0cm



De Bakey 1,5mm

Article No.	Size
AD.600.16	16,0cm
AD.600.20	20,0cm
AD.600.24	24,0cm



De Bakey 2,7mm

Article No.	Size
AD.604.16	16,0cm
AD.604.20	20,0cm
AD.604.24	24,0cm
AD.604.30	30,0cm



De Bakey 3,5mm

Article No.	Size
AD.606.16	16,0cm
AD.606.20	20,0cm
AD.606.24	24,0cm
AD.606.30	30,0cm



De Bakey 2,0mm

Article No.	Size
AD.612.16	16,0cm
AD.612.20	20,0cm
AD.612.24	24,0cm
AD.612.30	30,0cm





PINZAS PARA ESPINAS  
 PINCES À ÉCHARDES  
 PINZE PER SCHEGGE

## SPLITTERPINZETTEN SPLINTER FORCEPS

AD



Griffteil gerieft, mit Stift



Article No.	Size
AD.700.08	8,0cm
AD.700.09	9,0cm
AD.700.10	10,5cm
AD.700.11	11,5cm
AD.700.12	12,5cm



Article No.	Size
AD.701.08	8,0cm
AD.701.09	9,0cm
AD.701.10	10,5cm
AD.701.11	11,5cm
AD.701.12	12,5cm



Gerade ohne Stift

Splitter Pinzette

Article No.	Size
AD.704.08	8,0cm

**CILIENPINZETTEN**  
**CILIA FORCEPS**

PINZAS DEPILATORIAS  
PINCES À ÉPILER LES CILS  
PINZE DELPILATORIE

AD



Article No.	Size
AD.727.09	9,0cm



Article No.	Size
AD.728.09	9,0cm



Douglas

Article No.	Size
AD.730.09	9,0cm



Article No.	Size
AD.734.09	9,0cm

PINZAS DE DISECCIÓN CON INSERCIONES DE TUNGSTENO  
 PINCES PLAQUETTES EN CARBURE DE TUNGSTÈNE  
 PINZE PER DISSEZIONE CON TAGLIO IN CARBURO DI TUGSTENO

## HM PINZETTEN DISSECTING FORCEPS WITH TC

AD



Mit Hartmetall-  
einsätzen

With Tungsten  
Carbid inserts

Avec mors en métal dur  
Con puntas de metal duro  
Con punte in metallo duro



Standard

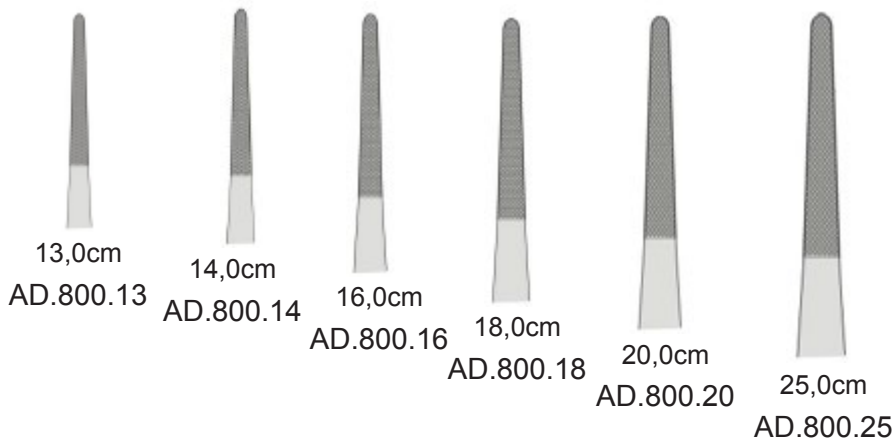

Semken

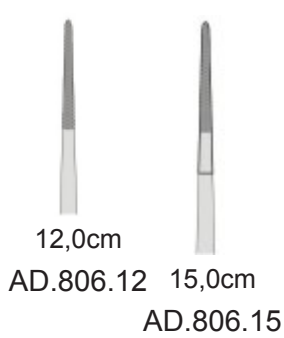

Adson

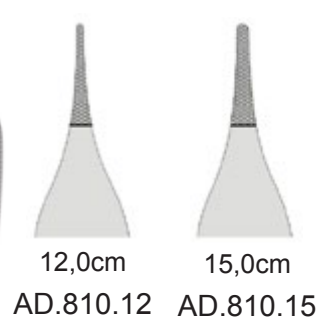

Adson

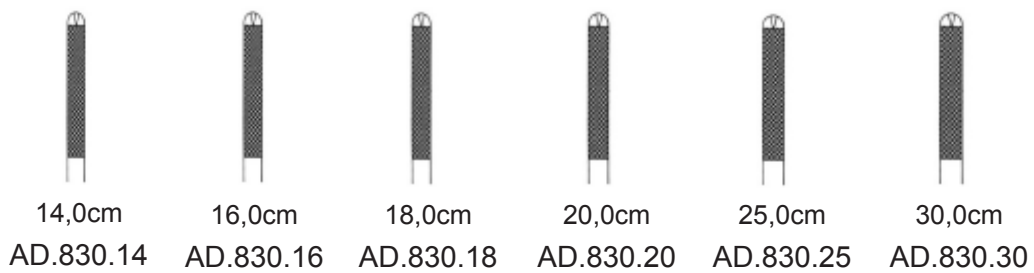
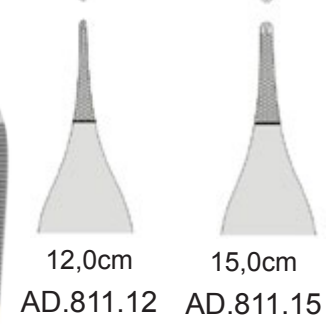

# HM PINZETTEN DISSECTING FORCEPS WITH TC

PINZAS DE DISECCIÓN CON INSERCIONES DE TUNGSTENO  
PINCES PLAQUETTES EN CARBURE DE TUNGSTÈNE  
PINZE PER DISSEZIONE CON TAGLIO IN CARBURO DI TUGSTENO

AD

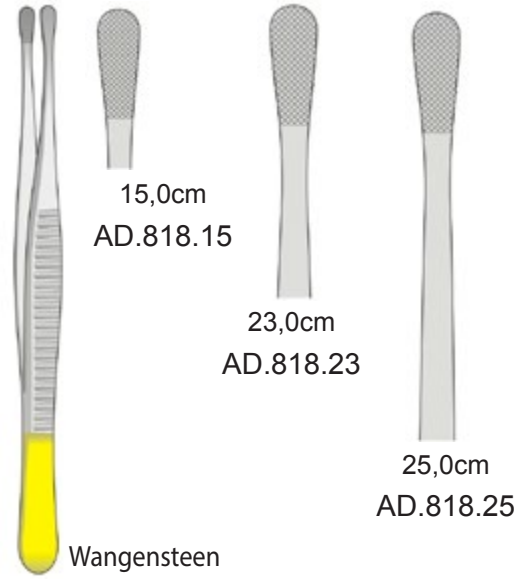
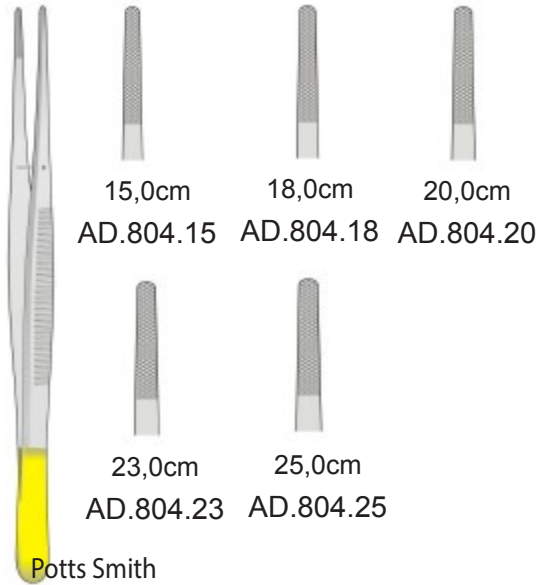

Mit Hartmetall-  
einsätzen

With Tungsten  
Carbid inserts

Avec mors en métal dur  
Con puntas de metal duro  
Con punte in metallo duro

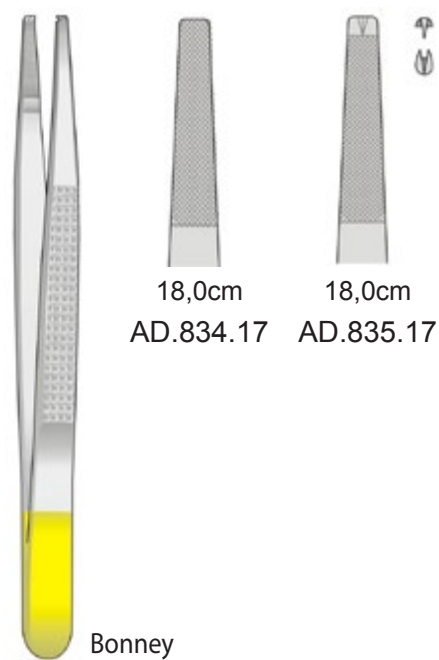
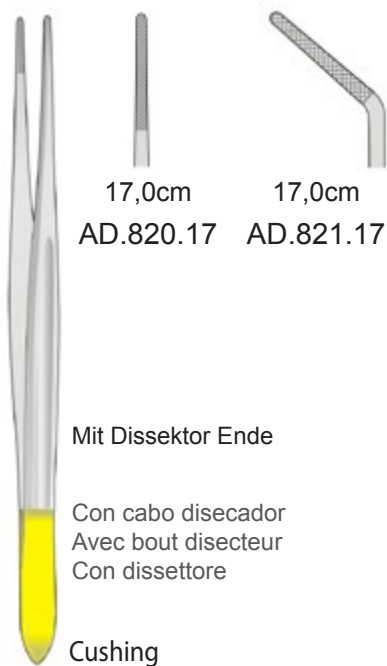





PINZAS DE DISECCIÓN CON INSERCIONES DE TUNGSTENO  
 PINCES PLAQUETTES EN CARBURE DE TUNGSTÈNE  
 PINZE PER DISSEZIONE CON TAGLIO IN CARBURO DI TUGSTENO

## HM PINZETTEN DISSECTING FORCEPS WITH TC

AD



DeBakey

			
16,0cm AD.850.16	16,0cm AD.851.16	16,0cm AD.852.16	16,0cm AD.853.16
20,0cm AD.850.20	20,0cm AD.851.20	20,0cm AD.852.20	20,0cm AD.853.20
25,0cm AD.850.25	25,0cm AD.851.25	25,0cm AD.852.25	



Evans

Article No.	Size
AD.855.25	25,0cm

**NADELHALTER**  
**NEEDLE HOLDERS**



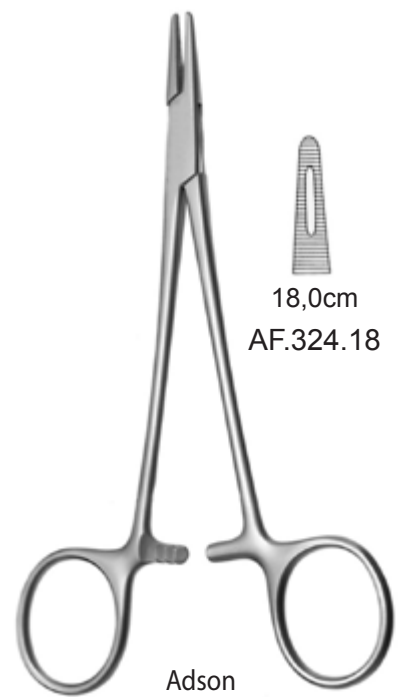
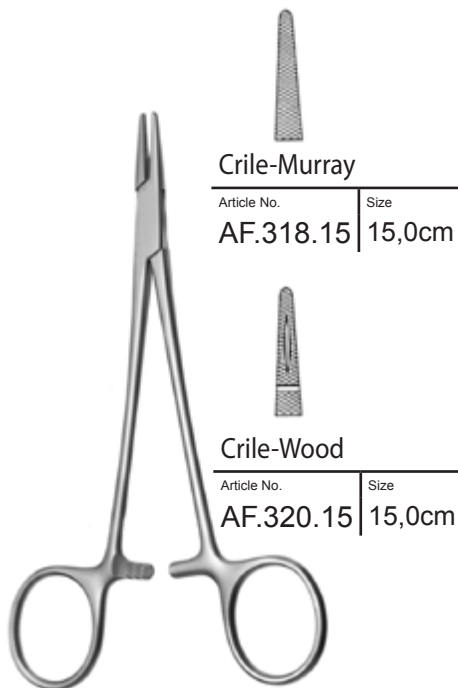
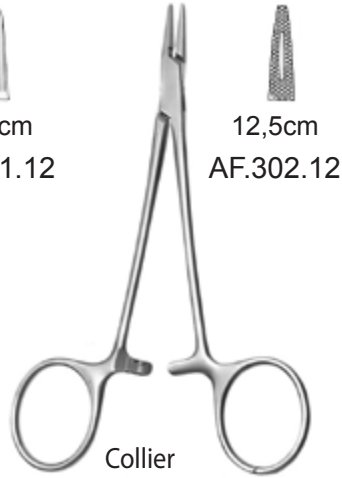

PORTA-AGUJAS  
PORTE-AIGUILLES  
PORTAGHI

**AF**

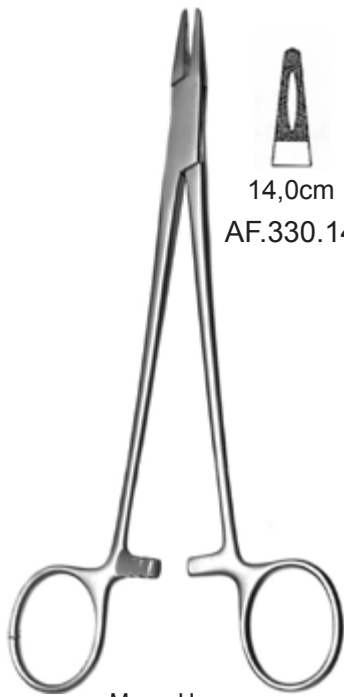

AF



- |   |   |   |   |   |   |
|---|---|---|---|---|---|
|  |  |  |  |  |  |
| 14,0cm  | 16,0cm  | 18,0cm  | 20,0cm  | 24,0cm  | 26,0cm  |
| AF.330.14   | AF.330.16   | AF.330.18   | AF.330.20   | AF.330.24   | AF.330.26   |

Mayo-Hegar



Heaney

Article No.	Size
AF.336.21	21,0cm



Masson

Article No.	Size
AF.340.27	27,0cm

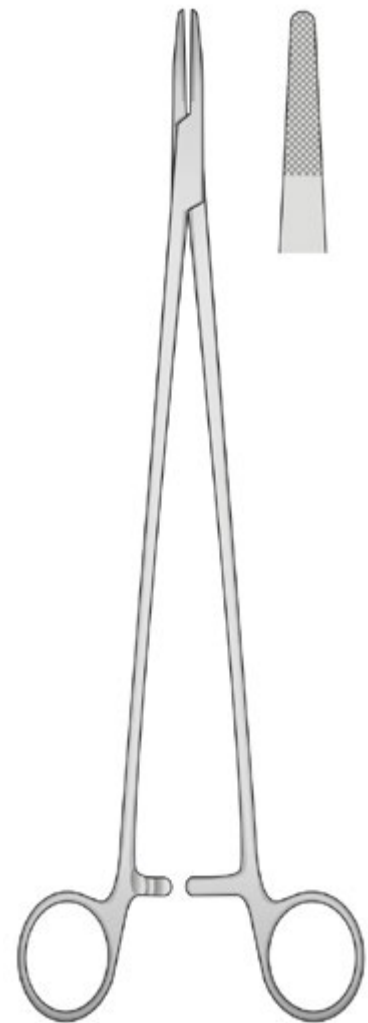

Wangensteen

Article No.	Size
AF.344.27	27,0cm

**NADELHALTER**  
**NEEDLE HOLDERS**

PORTA-AGUJAS  
PORTE-AIGUILLES  
PORTAGHI

AF



**Mathieu**

Article No.	Size
AF.380.14	14,0cm
AF.380.17	17,0cm
AF.380.20	20,0cm



**Mathieu Brazil**

Article No.	Size
AF.380.84	14,0cm



**Castroviejo gerade**

Article No.	Size
AF.430.14	14,0cm
AF.430.18	18,0cm
AF.430.22	22,5cm



**Castroviejo gebogen**

Article No.	Size
AF.431.14	14,0cm
AF.431.18	18,0cm
AF.431.22	22,5cm



PORTA-AGUJAS CON INSERCIÓNES DE TUNGSTENO  
 PORTE-AIGUILLES AVEC PLAQUETTES EN CARBURE DE TUNGSTÈNE  
 PORTAGHI CON INSERTI AL TUNGSTENO

**NADELHALTER MIT HM**  
**NEEDLE HOLDERS WITH TC**

AF

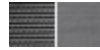

Mit Hartmetall-  
einsätzen

*With Tungsten  
Carbid inserts*

Avec mors en métal dur  
 Con puntas de metal duro  
 Con punte in metallo duro



Derf

Article No.	Size
AF.752.12	12,0cm

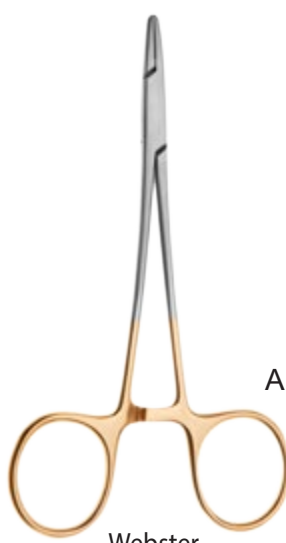

Webster



13,0cm  
AF.756.12



13,0cm  
AF.756.13



Halsey



13,0cm  
AF.758.13



13,0cm  
AF.760.13



Crile-Wood

Article No.	Size
AF.762.15	15,0cm
AF.762.18	18,0cm
AF.762.20	20,0cm
AF.762.23	23,0cm

**NADELHALTER MIT HM**  
**NEEDLE HOLDERS WITH TC**

PORTA-AGUJAS CON INSERCIONES DE TUNGSTENO  
 PORTE-AIGUILLES AVEC PLAQUETTES EN CARBURE DE TUNGSTÈNE  
 PORTAGHI CON INSERTI AL TUNGSTENO

AF



**Baby-Crile-Wood**

Article No.	Size
AF.763.15	15,0cm

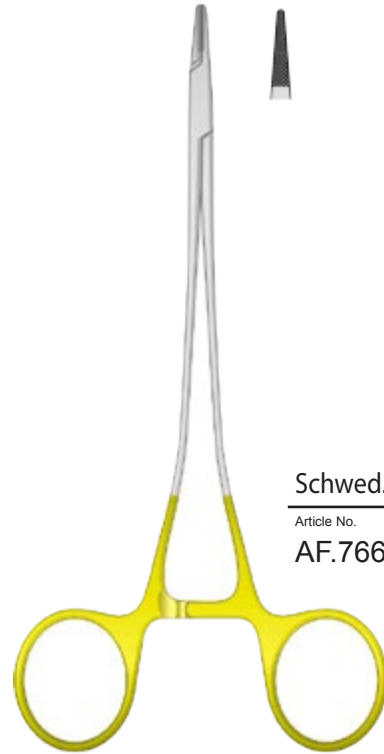

**Schwed. Modell**

Article No.	Size
AF.766.15	15,0cm

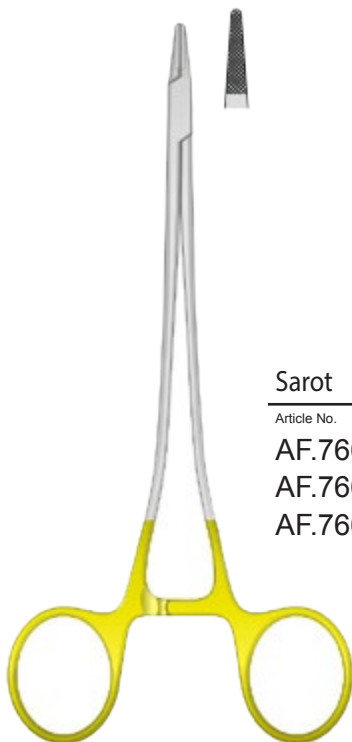

**Sarot**

Article No.	Size
AF.766.18	18,0cm
AF.766.20	20,0cm
AF.766.26	26,0cm



**Mayo-Hegar**

Article No.	Size
AF.768.14	14,0cm
AF.768.16	16,0cm
AF.768.18	18,0cm
AF.768.20	20,0cm
AF.768.24	24,0cm
AF.768.26	26,0cm

PORTA-AGUJAS CON INSERCIONES DE TUNGSTENO  
 PORTE-AIGUILLES AVEC PLAQUETTES EN CARBURE DE TUNGSTÈNE  
 PORTAGHI CON INSERTI AL TUNGSTENO

**NADELHALTER MIT HM**  
**NEEDLE HOLDERS WITH TC**

AF



Mayo-Hegar 20cm  
 starke Ausführung

Article No.	Size
AF.770.20	20,0cm

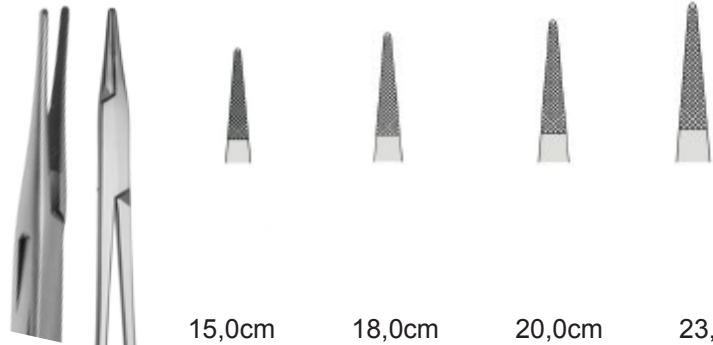

15,0cm	18,0cm	20,0cm	23,0cm
AF.771.15	AF.771.18	AF.771.20	AF.771.23



MEDE - Vascular



Mit Hartmetall-  
 einsetzen

With Tungsten  
 Carbide inserts

Avec mors en métal dur  
 Con puntas de metal duro  
 Con punte in metallo duro



18,0cm	20,0cm	23,0cm	26,0cm	31,0cm
AF.772.18	AF.772.20	AF.772.23	AF.772.26	AF.772.31



De Bakey

**NADELHALTER MIT HM**  
**NEEDLE HOLDERS WITH TC**

PORTA-AGUJAS CON INSERCIONES DE TUNGSTENO  
PORTE-AIGUILLES AVEC PLAQUETTES EN CARBURE DE TUNGSTÈNE  
PORTAGHI CON INSERTI AL TUNGSTENO

AF



**Masson**

Article No.	Size
AF.776.27	27,0cm

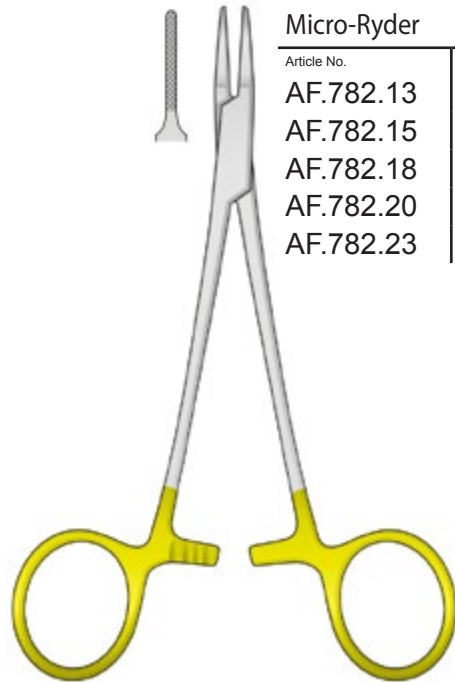

**Micro-Ryder**

Article No.	Size
AF.782.13	13,0cm
AF.782.15	15,0cm
AF.782.18	18,0cm
AF.782.20	20,0cm
AF.782.23	23,0cm



**Ryder (Frenche eye)**

Article No.	Size
AF.780.15	15,0cm
AF.780.18	18,0cm
AF.780.20	20,0cm



glattes Maul  
*smooth jaws*  
bocas lisas  
à mors lisses

**Ryder (Frenche eye)**

Article No.	Size
AF.781.18	18,0cm

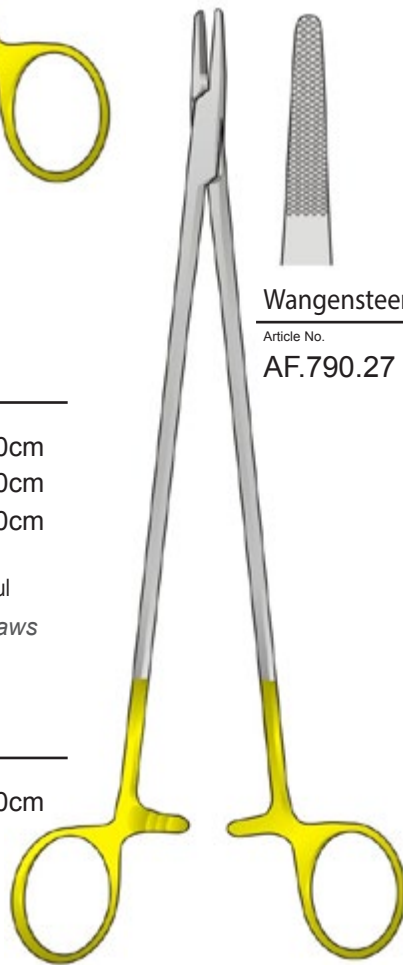

**Wangenstein**

Article No.	Size
AF.790.27	27,0cm

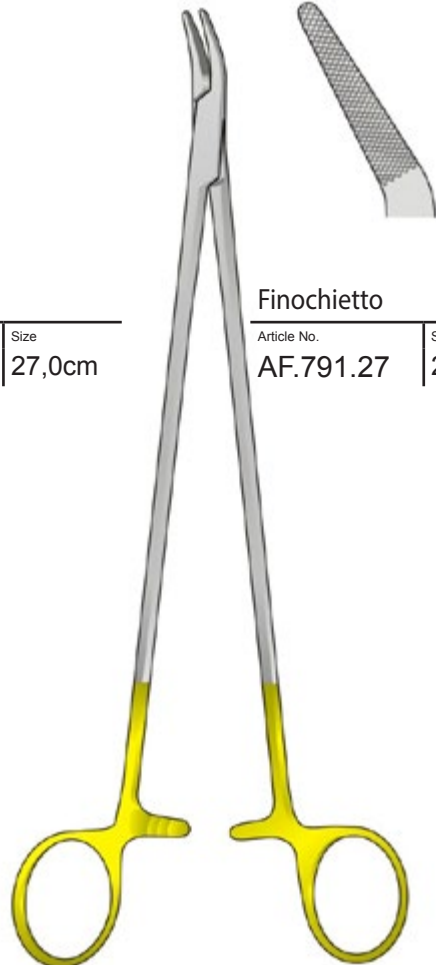

**Finochietto**

Article No.	Size
AF.791.27	27,0cm

PORTA-AGUJAS CON INSERCIONES DE TUNGSTENO  
 PORTE-AIGUILLES AVEC PLAQUETTES EN CARBURE DE TUNGSTÈNE  
 PORTAGHI CON INSERTI AL TUNGSTENO

**NADELHALTER MIT HM**  
**NEEDLE HOLDERS WITH TC**

AF

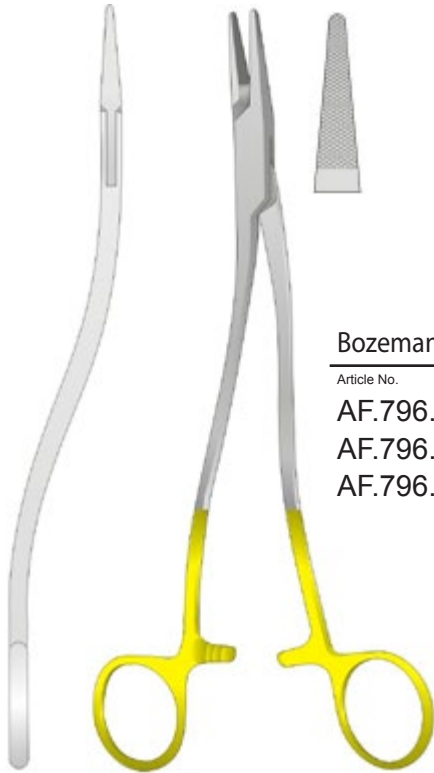

**Bozemann**

Article No.	Size
AF.796.20	20,0cm
AF.796.24	24,0cm
AF.796.26	26,0cm



Mit Hartmetall-  
einsätzen

*With Tungsten  
Carbid inserts*

Avec mors en métal dur  
 Con puntas de metal duro  
 Con punte in metallo duro



**Toennis TC**

Article No.	Size
AF.820.18	18,0cm



**Langenbeck TC**

Article No.	Size
AF.824.16	16,0cm
AF.824.18	18,0cm
AF.824.20	20,0cm
AF.824.23	23,0cm

**NADELHALTER MIT HM**  
**NEEDLE HOLDERS WITH TC**

PORTA-AGUJAS CON INSERCIONES DE TUNGSTENO  
PORTE-AIGUILLES AVEC PLAQUETTES EN CARBURE DE TUNGSTÈNE  
PORTAGHI CON INSERTI AL TUNGSTENO

AF



**Olsen-Hegar**

Article No.	Size
AF.800.12	12,0cm
AF.800.14	14,0cm
AF.800.17	17,0cm
AF.800.19	19,0cm



Mit Hartmetall-  
einsätzen

*With Tungsten  
Carbid inserts*

Avec mors en métal dur  
Con puntas de metal duro  
Con punte in metallo duro



**Mini-Gillis**

Article No.	Size
AF.802.12	12,0cm

**Gillis**

Article No.	Size
AF.802.15	15,0cm

PORTA-AGUJAS CON INSERCIONES DE TUNGSTENO  
PORTE-AIGUILLES AVEC PLAQUETTES EN CARBURE DE TUNGSTÈNE  
PORTAGHI CON INSERTI AL TUNGSTENO

## NADELHALTER MIT HM NEEDLE HOLDERS WITH TC

AF



Mathieu

Article No.	Size
AF.812.14	14,0cm
AF.812.17	17,0cm
AF.812.20	20,0cm



Mathieu

Article No.	Size
AF.814.17	17,0cm
AF.814.20	20,0cm

AF



Heggenbarth

Article No.	Size
AF.886.12	12,5cm



Collin

Article No.	Size
AF.892.13	13,0cm



Michel

Article No.	Size
AF.890.12	12,0cm



Michel

Article No.	Size
AF.891.13	13,0cm



Klammerentferner

Article No.	Size
AF.896.12	12,0cm

**FUNKTIONSWEISE | HOW TO USE**

Schieben Sie vorsichtig den untern Führungsarm des Klammerentferners unter die Klammer.



Insert the nose of the Manipler skin staple Remover firmly under the staple.

Schließen Sie den K-Entferner so das die Klammer anfängt sich zu verformen.



To reform the staple for removal,

Der K-Entferner muß vollkommen geschlossen sein so das die Klammer ganz geöffnet ist.



completely squeeze the handles until they are fully closed.

Erst jetzt können Sie die den Entferner samt Klammer von der Stelle entfernen.



With the handles closed, lift the staple straight up from the tissue.





Schmieden-Dick

Article No.	Size
AF.920.32	32,0cm



Schmieden

Article No.	Size
AF.922.21	21,0cm

Biegsam  
*malleable*  
 maleable  
 malléable  
 malleabile

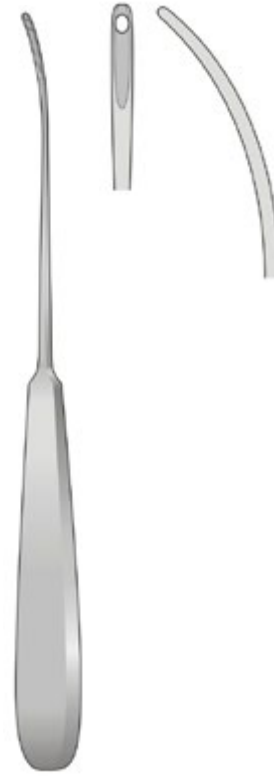

Article No.	Size
AF.924.20	20,0cm



Copper

Article No.	Size
AF.926.19	19,0cm

**UNTERBINDUNGSNADELN**  
**LIGATURE NEEDLES**

AGUJAS PARA LIGADURAS  
AIGUILLES À LIGATURES  
AGHI PER LEGATURA

**AF**



Stumpf  
*Blunt*  
Smusse  
Romas  
Mousses



**Kronecker**

Article No.	Size
AF.940.13	13,0cm

**Kronecker**

Article No.	Size
AF.942.13	13,0cm

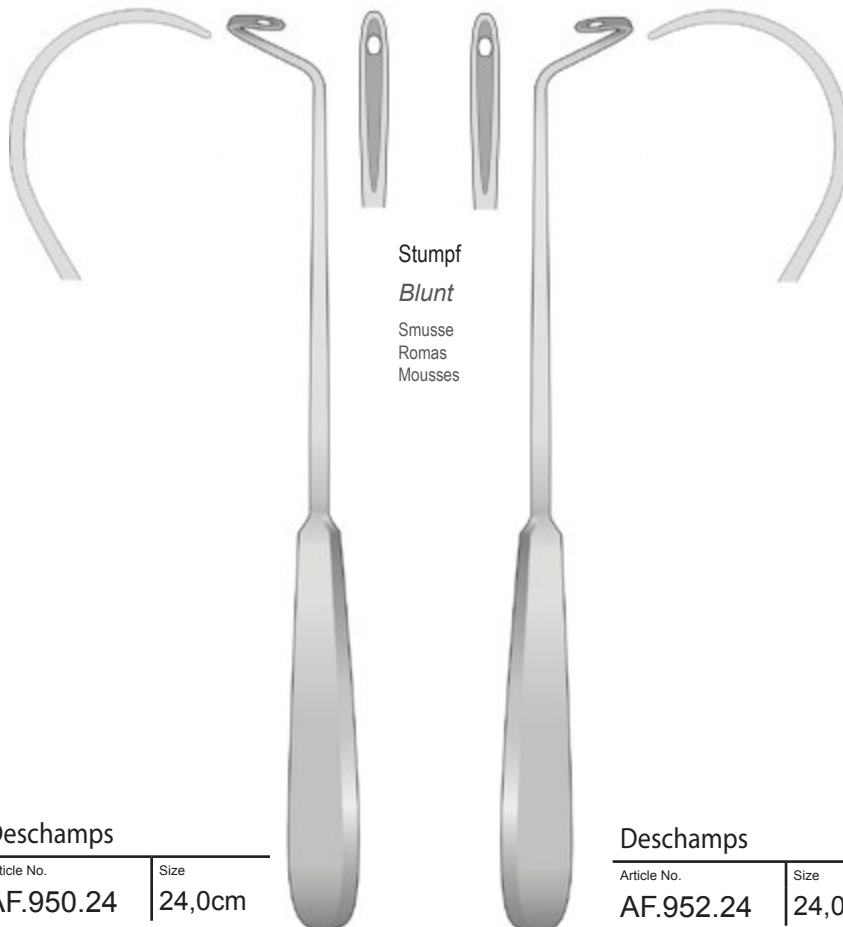

Stumpf  
*Blunt*  
Smusse  
Romas  
Mousses

**Deschamps**

Article No.	Size
AF.950.24	24,0cm

**Deschamps**

Article No.	Size
AF.952.24	24,0cm



Stumpf  
*Blunt*  
 Smusse  
 Romas  
 Mousses



Scharf  
*sharp*  
 agudo  
 pointue  
 acuti



Deschamps

Article No.	Size
AF.955.20	20,0cm

Deschamps

Article No.	Size
AF.956.20	20,0cm

Deschamps

Article No.	Size
AF.957.20	20,0cm

Deschamps

Article No.	Size
AF.958.20	20,0cm

**UNTERBINDUNGSNADELN**  
**LIGATURE NEEDLES**

AGUJAS PARA LIGADURAS  
AIGUILLES À LIGATURES  
AGHI PER LEGATURA

**AF**

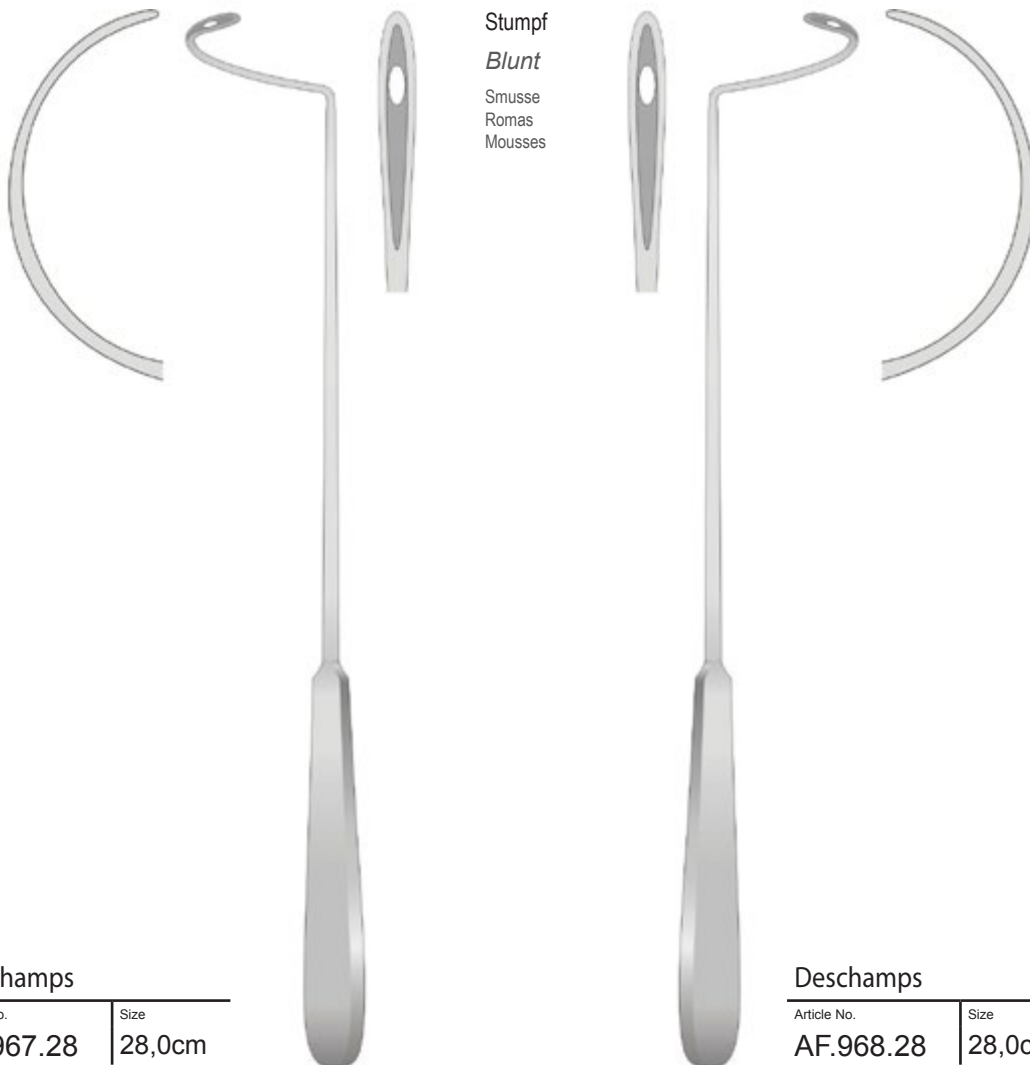

AF

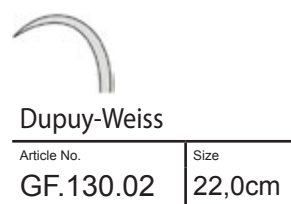
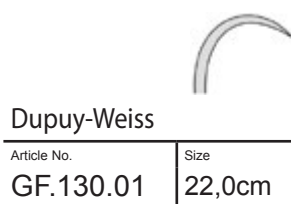
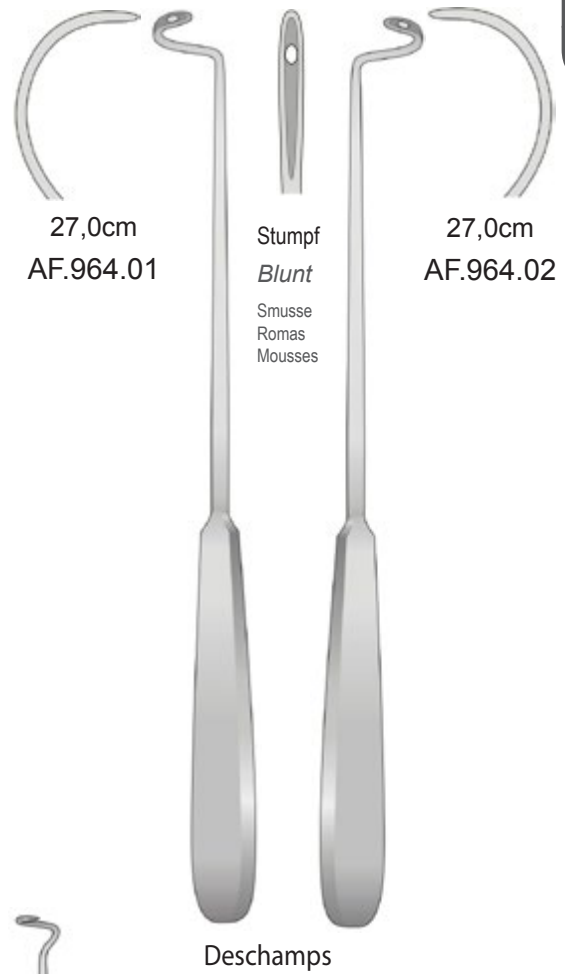
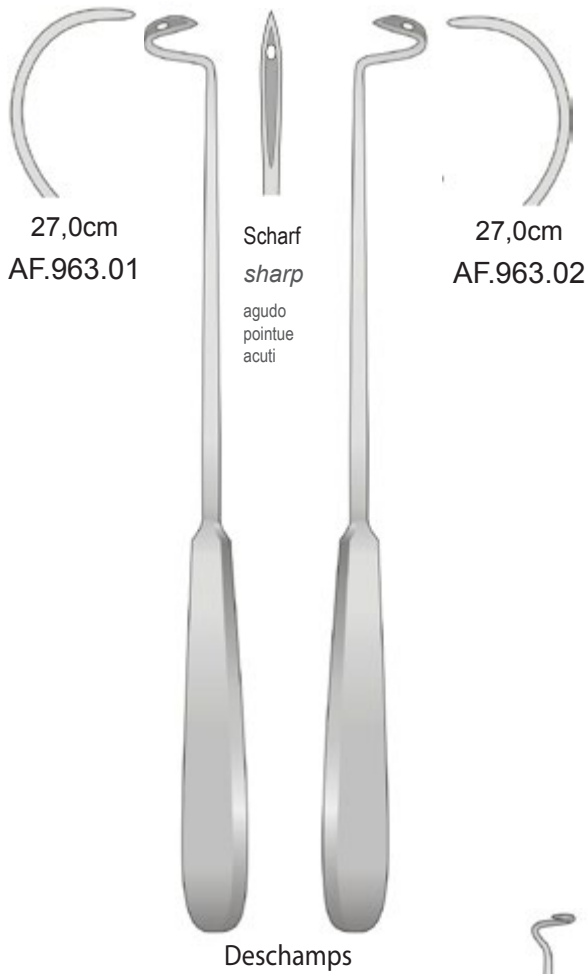

**FÜHRUNGSHOHLSONDEN**  
**LIGATURE CONDUCTORS**

SONDAS CONDUCTORAS  
 SONDES CONDUCTRICES  
 SONDE CONDUTTRICI

AF



rechts gebogen  
für die linke Hand

28,0cm  
AF.968.28

Deschamps  
Unterbindungsnadel

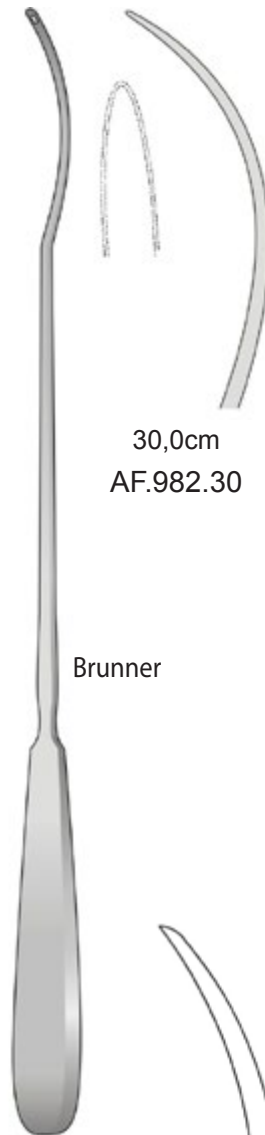

30,0cm  
AF.982.30

Brunner



30,0cm  
AF.983.30



25,5cm  
AF.984.25

Kirschner



22,0cm  
AF.996.01

Payer



22,0cm  
AF.996.02

Payer



Brunner Hohlsonde

Article No.	Size
AF.987.18	18,0cm



9mm breit

Brunner Hohlsonde

Article No.	Size
AF.987.27	27,0cm



9mm breit

Kirschner Hohlsonde

Article No.	Size
AF.988.27	27,0cm

**FÜHRUNGSHOHLSONDEN**  
**LIGATURE CONDUCTORS**

SONDAS CONDUCTORAS  
SONDES CONDUCTRICES  
SONDE CONDUTTRICI

AF



Kocher

Article No.	Size
AF.986.01	16,0cm



Kocher

Article No.	Size
AF.986.02	16,0cm



Schmieden

Article No.	Size
AF.993.19	19,0cm



Schmieden-Payr

Article No.	Size
AF.994.19	19,0cm



König 19,5cm

Article No.	Size
AF.995.03	2,5mm
AF.995.05	5,0mm
AF.995.07	7,0mm







Brunner-Ferrozell

Article No.	Size
AF.987.18	18,5cm



Kirschner-Ferrozell

Article No.	Size
AF.987.27	27,0cm



Ferrozell

Article No.	Size
AF.992.24	24,0cm

11mm breit



MEDE Hohlsonde gebogen

Article No.	Size
AF.990.01	19,0cm

MEDE Hohlsonde gerade

Article No.	Size
AF.990.02	19,0cm

**ARTERIENKLEMMEN**  
**HEMOSTATIC FORCEPS**

PINZAS HEMOSTÁTICAS  
PINCES HÉMOSTATIQUES  
PINZE EMOSTATICHE

AH

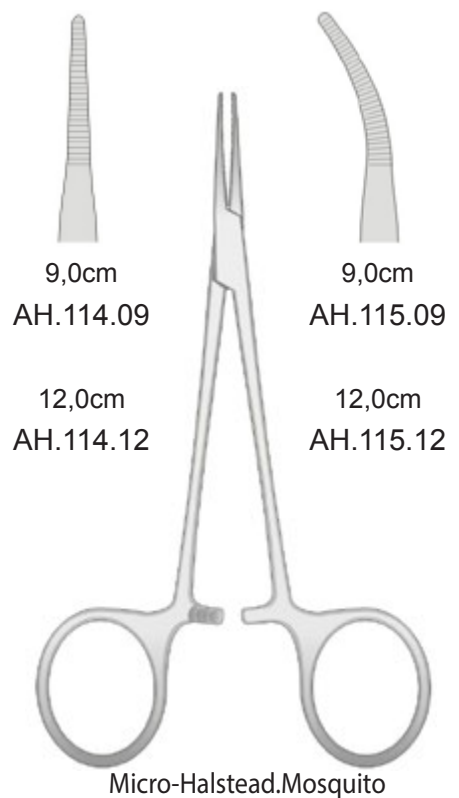
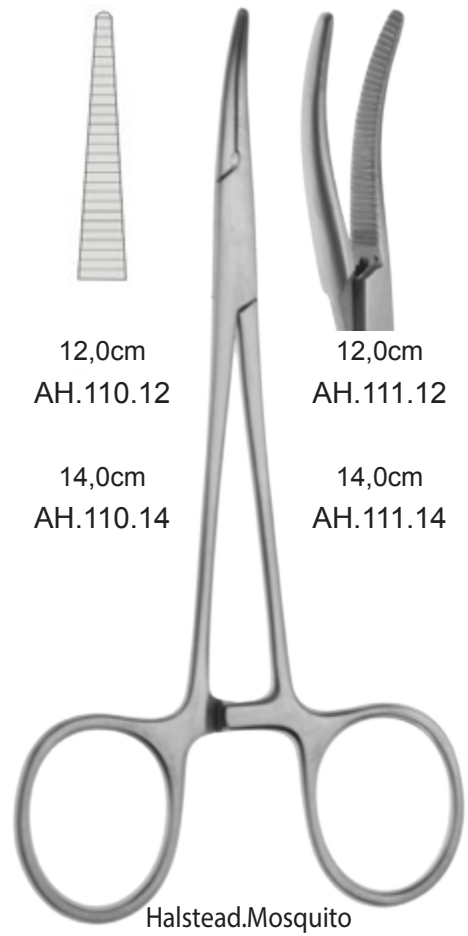

**ARTERIENKLEMMEN**  
**HEMOSTATIC FORCEPS**

AH

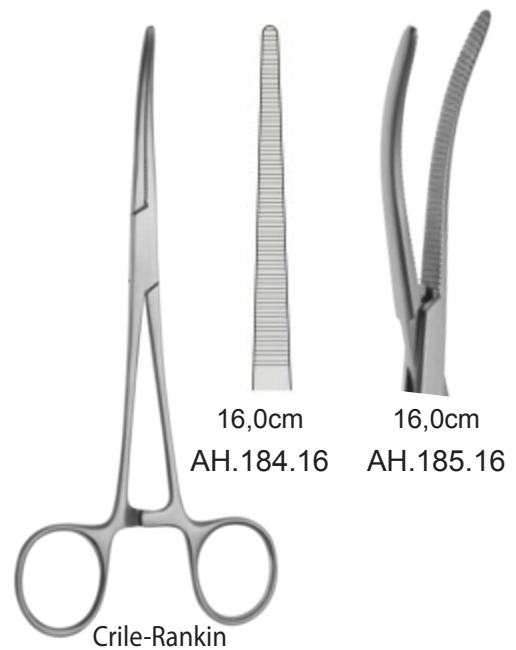
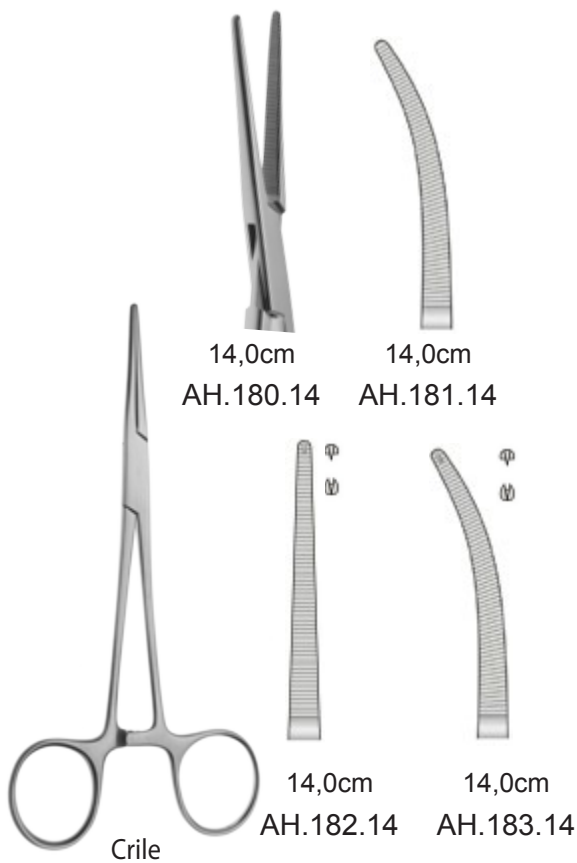
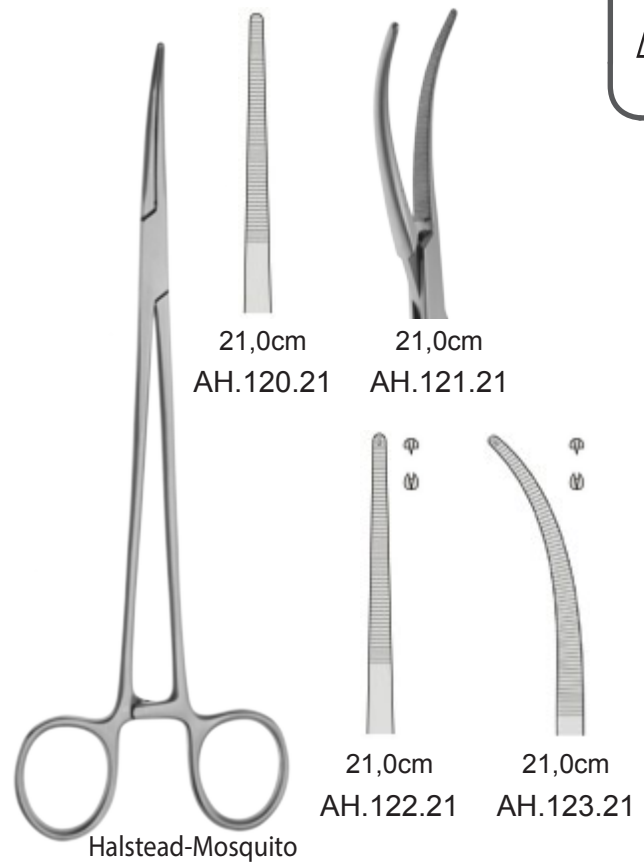
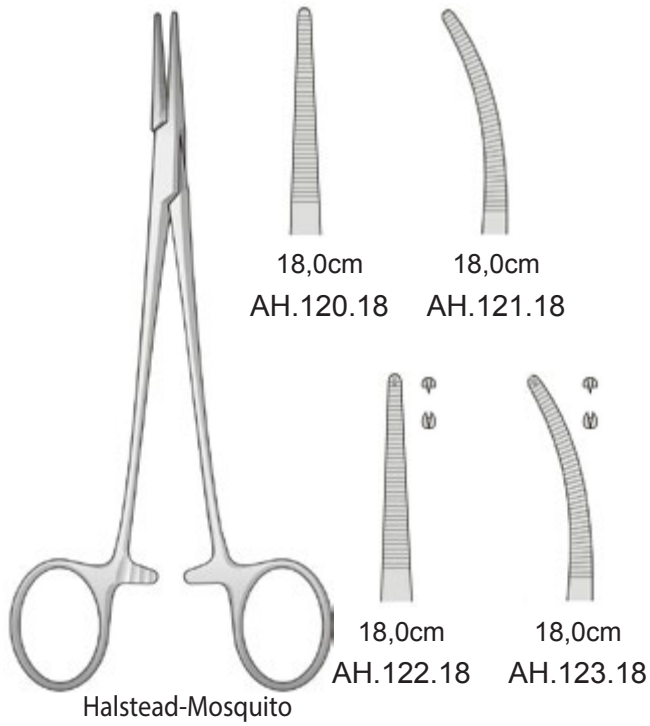

**ARTERIENKLEMMEN**  
**HEMOSTATIC FORCEPS**

PINZAS HEMOSTÁTICAS  
PINCES HÉMOSTATIQUES  
PINZE EMOSTATICHE

AH

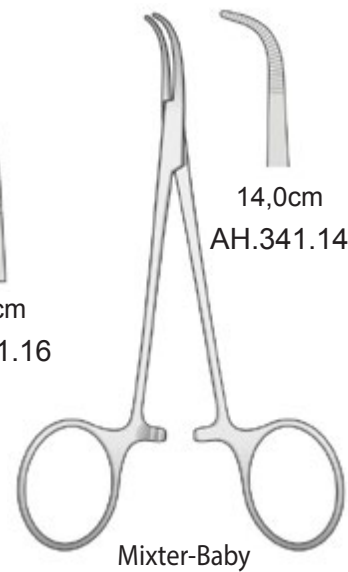
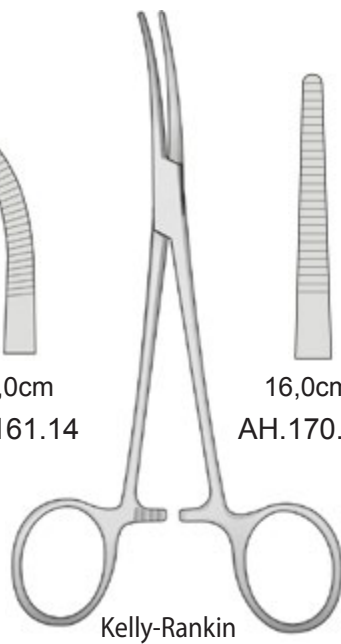
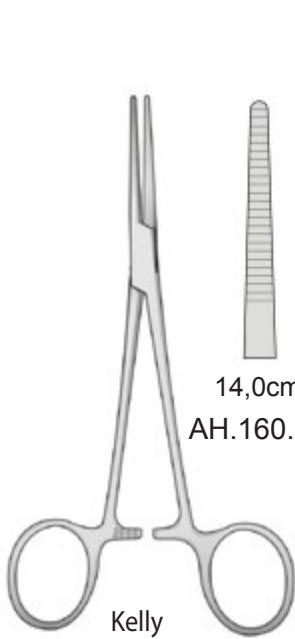
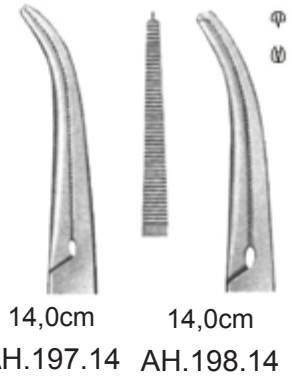
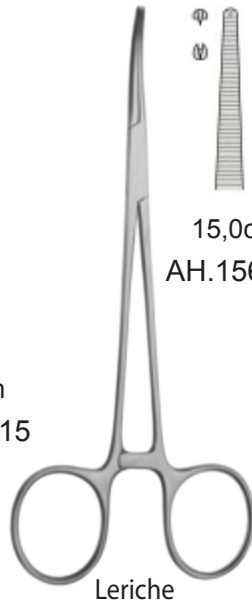
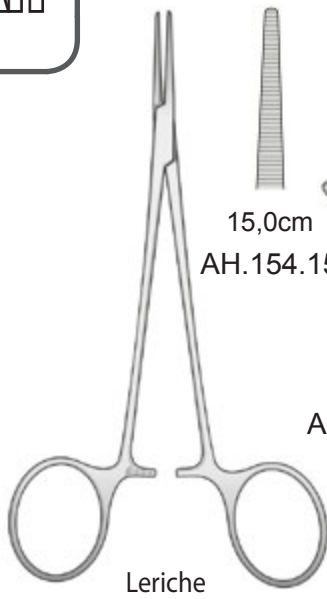



20,0cm  
AH.240.20



**ARTERIENKLEMMEN**  
**HEMOSTATIC FORCEPS**

PINZAS HEMOSTÁTICAS  
PINCES HÉMOSTATIQUES  
PINZE EMOSTATICHE

AH



Rochester-Pean

Article No.	Size
AH.250.13	13,0cm
AH.250.14	14,0cm
AH.250.16	16,0cm
AH.250.18	18,0cm
AH.250.20	20,0cm
AH.250.22	22,0cm
AH.250.24	24,0cm
AH.250.26	26,0cm
AH.250.28	28,0cm
AH.250.30	30,0cm



Rochester-Pean

Article No.	Size
AH.251.13	13,0cm
AH.251.14	14,0cm
AH.251.16	16,0cm
AH.251.18	18,0cm
AH.251.20	20,0cm
AH.251.22	22,0cm
AH.251.24	24,0cm
AH.251.26	26,0cm
AH.251.28	28,0cm
AH.251.30	30,0cm



Ochsner-Kocher

Article No.	Size
AH.260.14	14,0cm
AH.260.16	16,0cm
AH.260.18	18,0cm
AH.260.20	20,0cm
AH.260.22	22,0cm
AH.260.24	24,0cm
AH.260.26	26,0cm
AH.260.30	30,0cm



Ochsner-Kocher

Article No.	Size
AH.261.14	14,0cm
AH.261.16	16,0cm
AH.261.18	18,0cm
AH.261.20	20,0cm
AH.261.22	22,0cm
AH.261.24	24,0cm
AH.261.26	26,0cm
AH.261.30	30,0cm

# ARTERIENKLEMMEN HEMOSTATIC FORCEPS

PINZAS HEMOSTÁTICAS  
PINCES HÉMOSTATIQUES  
PINZE EMOSTATICHE

AH



Crafoord

Article No.	Size
AH.303.18	18,0cm
AH.303.24	24,0cm

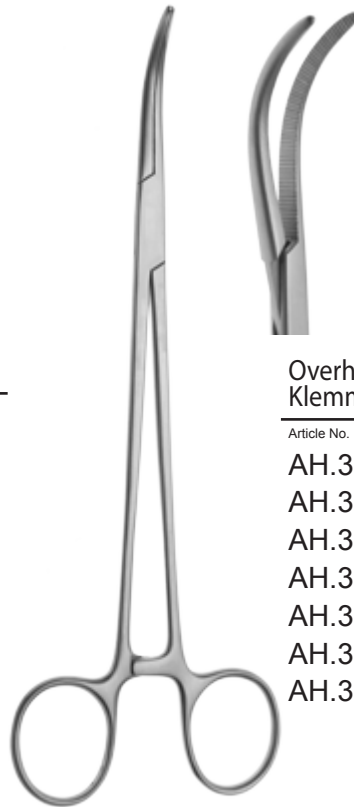

Overholt-Geissendoerfer  
Klemme 21,0cm

Article No.	Size
AH.311.01	Fig. 1
AH.311.02	Fig. 2
AH.311.03	Fig. 3
AH.311.04	Fig. 4
AH.311.05	Fig. 5
AH.311.06	Fig. 6
AH.311.07	Fig. 7



Overholt-Geissendoerfer  
Klemme 27,0cm

Article No.	Size
AH.313.01	Fig. 1
AH.313.02	Fig. 2
AH.313.03	Fig. 3
AH.313.07	Fig. 7



Wickström

Article No.	Size
AH.355.21	21,0cm
AH.355.24	24,0cm

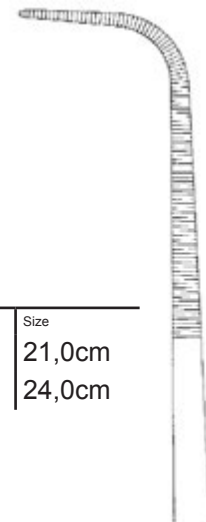



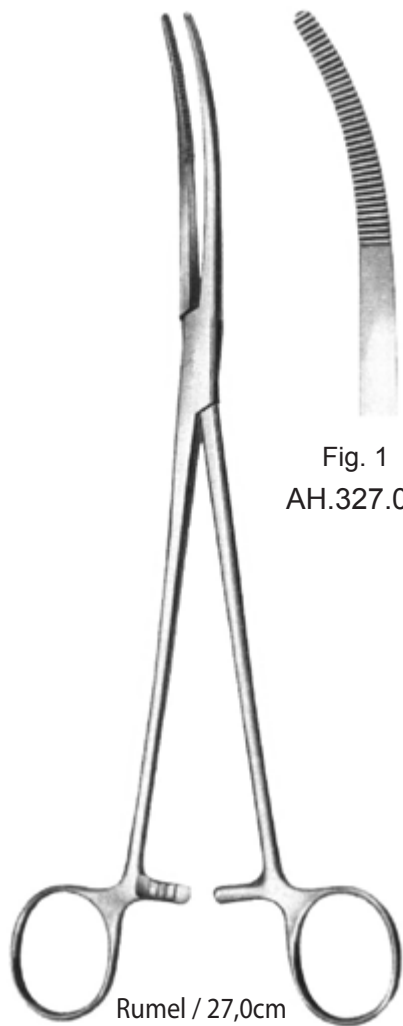

Rumel / 27,0cm



Fig. 1  
AH.327.01



Fig. 2  
AH.327.02



Fig. 3  
AH.327.03



Fig. 4  
AH.327.04



Fig. 5  
AH.327.05



Meeker

Article No.	Size
AH.413.27	27,5cm

**ARTERIENKLEMMEN**  
**HEMOSTATIC FORCEPS**

PINZAS HEMOSTÁTICAS  
PINCES HÉMOSTATIQUES  
PINZE EMOSTATICHE

AH



**Gemini**

Article No.	Size
AH.323.13	13,0cm
AH.323.16	16,0cm
AH.323.18	18,0cm
AH.323.20	20,0cm
AH.323.23	23,0cm
AH.323.25	25,0cm
AH.323.28	28,0cm



**Mixer**

Article No.	Size
AH.343.15	15,5cm
AH.343.19	19,0cm

PINZAS PARA LIGADURAS  
PINCES À LIGATURES  
PINZE PER LEGATURE

**LIGATURZANGEN**  
**LIGATURE FORCEPS**

AH



Ligaturklemme

Article No.	Size
AH.338.28	28,0cm

**PERITONEUMKLEMMEN**  
**PERITONAL CLAMP FORCEPS**

PINZAS-CLAMPS PARA PERITONEO  
 PINCES-CLAMPS POUR LE PÉRITOINE  
 PINZE PER PERITONEO

AH

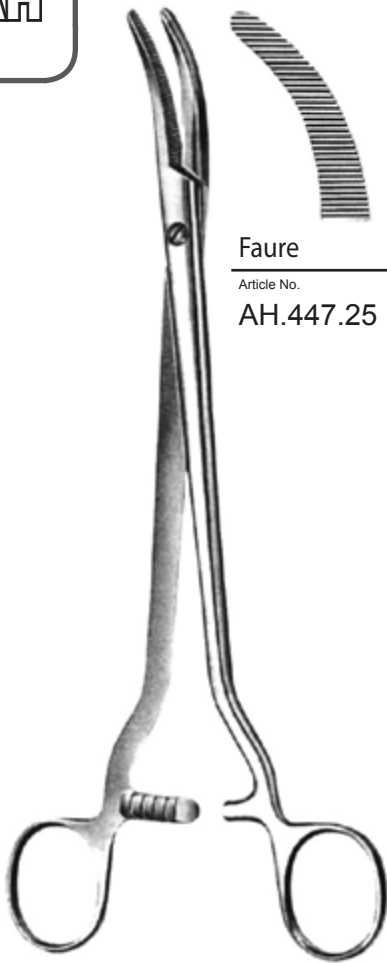

Faure

Article No.	Size
AH.447.25	25,0cm



20,0cm  
 AH.481.20

20,0cm  
 AH.483.20

Faure



Mikulicz

Article No.	Size
AH.477.20	20,0cm

PINZAS CON BOCAS  
PINCES-CLAMOPS  
PINZE CLAMP

GEFÄSSKLEMMEN  
VESSEL CLAMP

AH

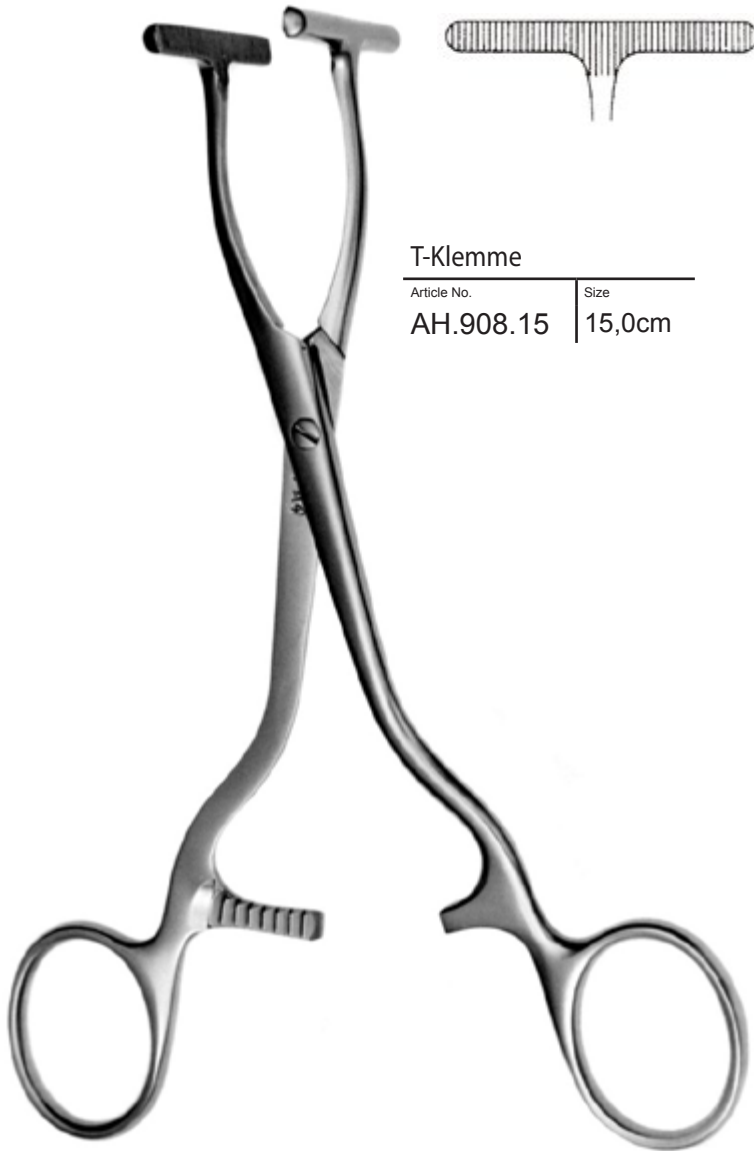

T-Klemme

Article No.	Size
AH.908.15	15,0cm



Höpfner

Article No.	Size
DA.520.16	16,0cm

**GEWEBEFASSZANGEN**  
**TISSUE SEIZING FORCEPS**

PINZAS PARA COGER EL TEJIDOS  
 PINCE POUR SAISIR LETISSU  
 PINZE PER AFFERRARE IL TISSUTO

AI



**Allis-Baby**

Article No.	Size
AI.100.12	12,0cm

**Allis 5x6Zähne**

Article No.	Size
AI.104.15	15,0cm
AI.104.19	19,0cm
AI.104.25	25,0cm



**Allis 4x5Zähne**

Article No.	Size
AI.102.15	15,0cm

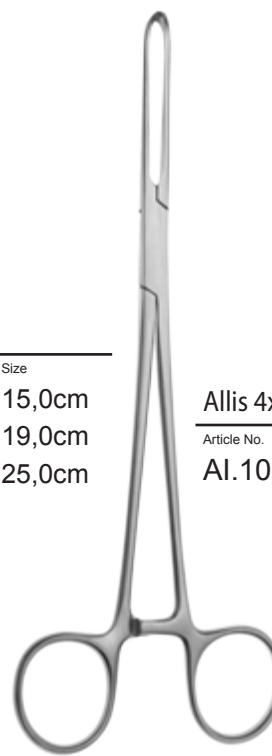

**Allis-Atraumatisch**

Article No.	Size
AI.110.16	15,5cm



**Allis-Atraumatisch**

Article No.	Size
AI.110.20	20,0cm
AI.110.25	25,0cm
AI.110.30	30,0cm

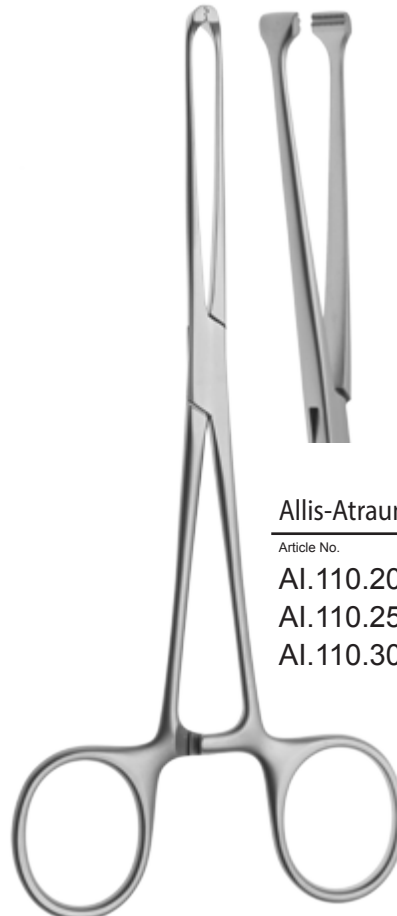

AJ

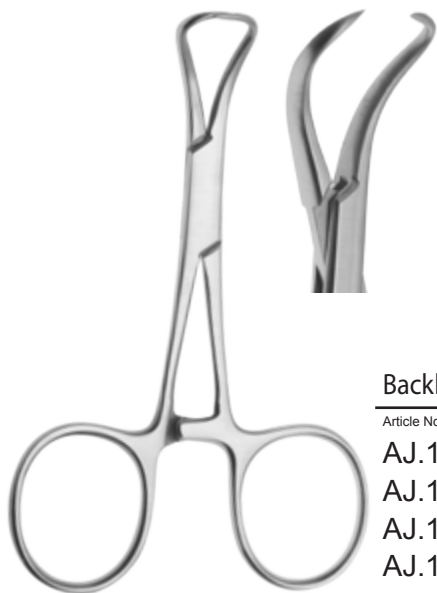

Backhaus

Article No.	Size
AJ.110.09	9,0cm
AJ.110.11	11,0cm
AJ.110.13	13,0cm
AJ.110.15	15,0cm



Kugel und Pfanne

Article No.	Size
AJ.114.09	9,0cm
AJ.114.11	11,0cm
AJ.114.13	13,0cm



Lorna

Article No.	Size
AJ.118.10	10,0cm
AJ.118.13	13,0cm



Bernhard

Article No.	Size
AJ.122.16	16,0cm



Tohoku

Article No.	Size
AJ.128.10	10,0cm
AJ.128.13	13,0cm

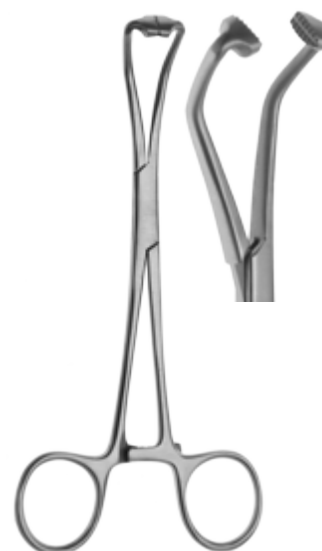

Bertram

Article No.	Size
AJ.130.14	14,0cm

**SCHLAUCHKLEMMEN**  
**TUBING CLAMPS**

PINZAS PARA TUBOS  
PINCES PRESSE-TUBES  
PINZE PER TUBI

AK



**Schlauchklemme**

Article No.	Size
AK.110.14	14,0cm
AK.110.16	16,0cm
AK.110.18	18,0cm
AK.110.20	20,0cm



**Schlauchklemme m. Bügel**

Article No.	Size
AK.114.15	15,0cm
AK.114.18	18,0cm
AK.114.20	20,0cm



PINZAS PARA TUBOS  
PINCES PRESS-TUBES  
PINZE PER TUBI

## ROLLENSCHLAUCHKLEMMEN TUBING CLAMPS

AK

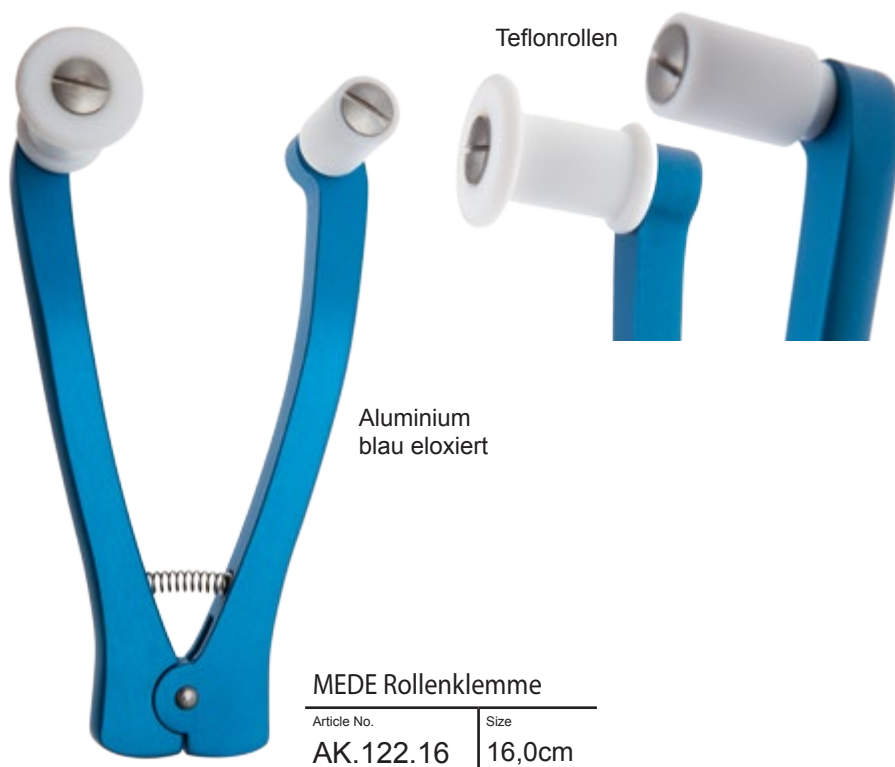

**KORNZANGEN**  
**SPONGE AND DRESSING FORCEPS**

PINZAS PARA PÓLIPOS Y VENDAJES  
 PINCES À TAMPONS  
 PINZE PER TAMPONI E MEDICATURA UTERINA

AL



Urlich

Article No.	Size
AL.102.18	18,0cm
AL.102.20	20,0cm
AL.102.22	22,0cm
AL.102.25	25,0cm
AL.102.27	27,0cm

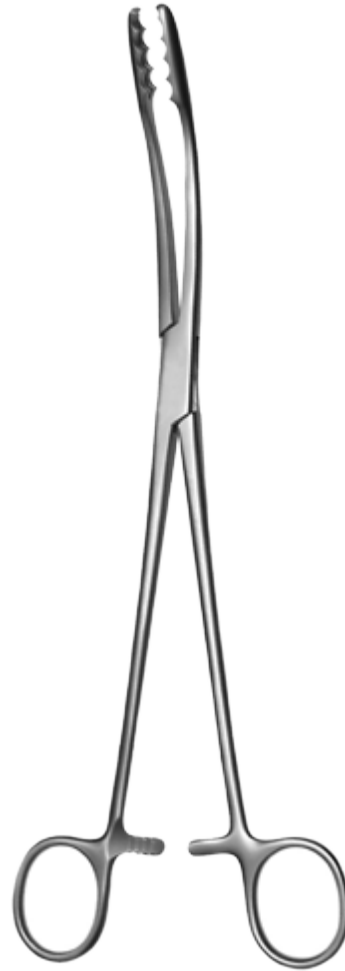

Urlich

Article No.	Size
AL.103.22	22,0cm
AL.103.25	25,0cm
AL.103.27	27,0cm

AL



Gross-Maier

Article No.	Size
AL.120.20	20,0cm
AL.120.25	26,5cm

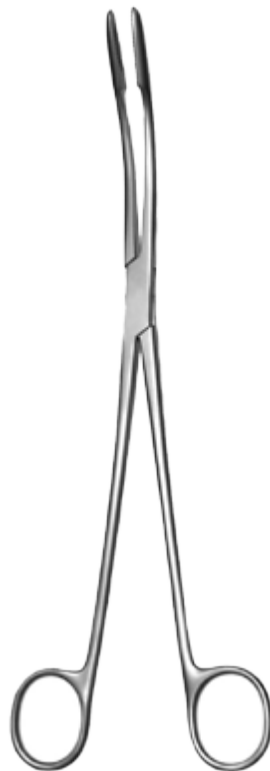

Gross-Maier

Article No.	Size
AL.121.25	26,0cm



Gross-Maier

Article No.	Size
AL.122.16	16,0cm
AL.122.20	20,0cm
AL.122.22	22,0cm
AL.122.25	26,0cm
AL.122.27	27,0cm



Gross-Maier

Article No.	Size
AL.123.20	20,0cm
AL.123.25	25,0cm
AL.123.26	26,0cm
AL.123.27	27,0cm
AL.123.35	35,0cm
AL.123.60	60,0cm

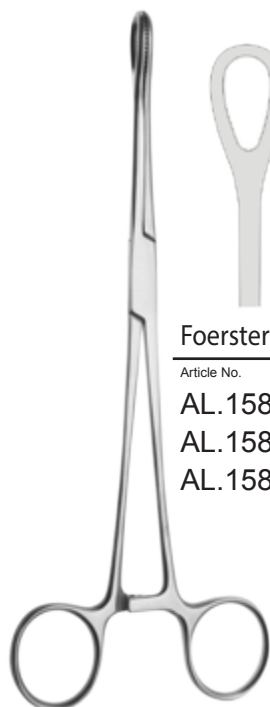

Foerster

Article No.	Size
AL.158.18	18,0cm
AL.158.20	20,0cm
AL.158.25	25,0cm



Foerster

Article No.	Size
AL.160.18	18,0cm
AL.160.20	20,0cm
AL.160.25	25,0cm

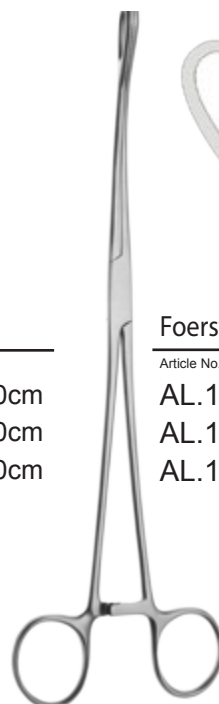

Foerster

Article No.	Size
AL.159.18	18,0cm
AL.159.20	20,0cm
AL.159.25	25,0cm



Foerster

Article No.	Size
AL.161.18	18,0cm
AL.161.20	20,0cm
AL.161.25	25,0cm

**KORNZANGEN**  
**SPONGE AND DRESSING FORCEPS**

PINZAS PARA PÓLIPOS Y VENDAJES  
 PINCES À TAMPONS  
 PINZE PER TAMPONI E MEDICATURA UTERINA

**AL**



**Rampley**

Article No.	Size
AL.176.18	18,0cm
AL.176.25	25,0cm

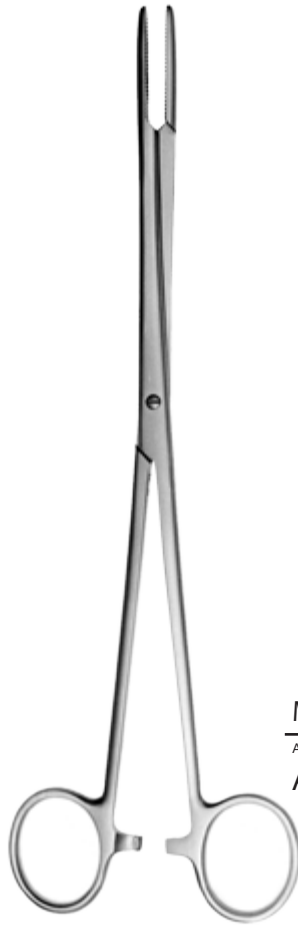

**Maier**

Article No.	Size
AL.178.24	24,5cm



**Maier**

Article No.	Size
AL.179.24	24,5cm



Kappenzange

Article No.	Size
AL.190.21	21,0cm
AL.190.25	25,0cm
AL.190.31	31,0cm
AL.190.32	32,0cm
AL.190.46	46,0cm



**WUNDHAKEN**  
**RETRACTORS**

SEPARADORES  
ECARTEURS  
DIVARICATORI

AM



Tracheal Hä kchen scharf  
16,0cm

Article No.	Size
AM.060.01	1 Zahn
AM.060.02	2 Zähne
AM.060.03	3 Zähne
AM.060.04	4 Zähne



Tracheal Hä kchen stumpf  
16,0cm

Article No.	Size
AM.061.01	1 Zahn
AM.061.02	2 Zähne
AM.061.03	3 Zähne
AM.061.04	4 Zähne



Federhäkchen  
spitz 16,0cm

Article No.	Size
AM.064.01	1 Zahn
AM.064.02	2 Zähne
AM.064.03	3 Zähne
AM.064.04	4 Zähne



Federhäkchen  
stumpf 16,0cm

Article No.	Size
AM.065.01	1 Zahn
AM.065.02	2 Zähne
AM.065.03	3 Zähne
AM.065.04	4 Zähne

**WUNDHAKEN**  
**RETRACTORS**

SEPARADORES  
ECARTEURS  
DIVARICATORI

AM



Desmarres 16,0cm

Article No.	Size
AM.071.08	8mm
AM.071.10	10mm
AM.071.12	12mm
AM.071.14	14mm
AM.071.16	16mm
AM.071.18	18mm



Desmarres 16,0cm

Article No.	Size
AM.072.12	12mm
AM.072.14	14mm
AM.072.16	16mm
AM.07.218	18mm

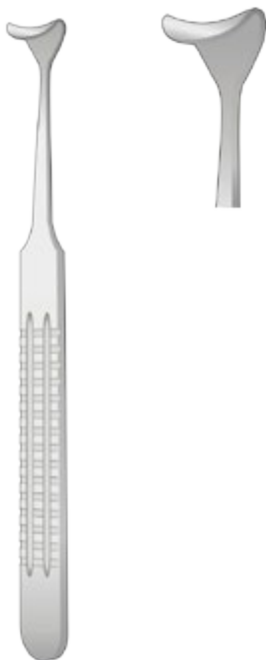

Desmarres

Article No.	Size
AM.853.16	16,0cm



Senn-Green 20x6mm

Article No.	Size
AM.087.02	15,0cm



Senn-Green 10x6mm

Article No.	Size
AM.087.01	15,0cm





Tracheal Hakchen  
scharf 16cm

Article No.	Size
AM.080.01	1Zahn
AM.080.02	2Zahne
AM.080.03	3Zahne
AM.080.04	4Zahne



Tracheal Hakchen  
stumpf 16cm

Article No.	Size
AM.081.01	1Zahn
AM.081.02	2Zahne
AM.081.03	3Zahne
AM.081.04	4Zahne

**WUNDHAKEN  
RETRACTORS**

SEPARADORES  
ECARTEURS  
DIVARICATORI

**AM**



Ragnell-Davis

Article No.	Size
AM.088.14	14,0cm



Ragnell

Article No.	Size
AM.088.15	15,0cm



Converse

Article No.	Size
AM.088.92	12,0cm



Senn-Mueller

Article No.	Size
AM.090.16	16,0cm

Spitz  
*Sharp*  
Acute  
Agudas  
Pointus

Stumpf  
*Blunt*  
Smusse  
Romas  
Mousses

16,0cm  
AM.091.16



Lahey

Article No.	Size
AM.093.19	19,5cm



Cushing

Article No.	Size
AM.093.20	20,0cm



Wassmund

Article No.	Size
AM.131.02	20,0cm

SEPARADORES  
 ECARTEURS  
 DIVARICATORI

10x10mm



Cushing-Kocher

Article No.	Size
AM.099.18	16,0cm

WUNDHAKEN  
 RETRACTORS

AM



Cushing 25,0cm

Article No.	Size
AM.103.11	14x11mm
AM.103.13	18x13mm
AM.103.15	22x15mm

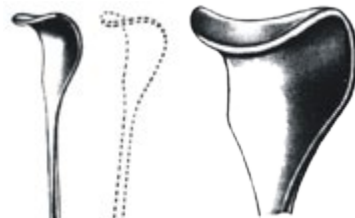

Gil-Vernet 28,0cm

Article No.	Size
AM.106.09	9mm
AM.106.11	11mm
AM.106.13	13mm
AM.106.15	15mm
AM.106.18	18mm

**WUNDHAKEN  
RETRACTORS**

SEPARADORES  
ECARTEURS  
DIVARICATORI

**AM**



Scharf  
*sharp*  
agudo  
pointue  
acuti

21,5cm  
AM.115.01



Stumpf  
*Blunt*  
Smusse  
Romas  
Mousses

21,5cm  
AM.116.01



Halbscharf  
*Semi-sharp*  
Semiagudo  
Semi-pointu  
Semi acuto

21,5cm  
AM.117.01

Volkman



Scharf  
*sharp*  
agudo  
pointue  
acuti

24,5cm  
AM.116.11



Scharf  
*sharp*  
agudo  
pointue  
acuti

22,0cm  
AM. 120.01

Kocher



Stumpf  
*Blunt*  
Smusse  
Romas  
Mousses

22,0cm  
AM. 121.01

Kocher



Halbscharf  
*Semi-sharp*  
Semiagudo  
Semi-pointu  
Semi acuto

22,0cm  
AM. 122.01

Kocher

SEPARADORES  
 ECARTEURS  
 DIVARICATORI

**WUNDHAKEN**  
**RETRACTORS**

AM

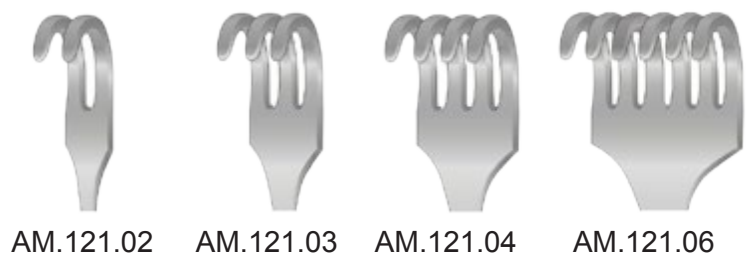
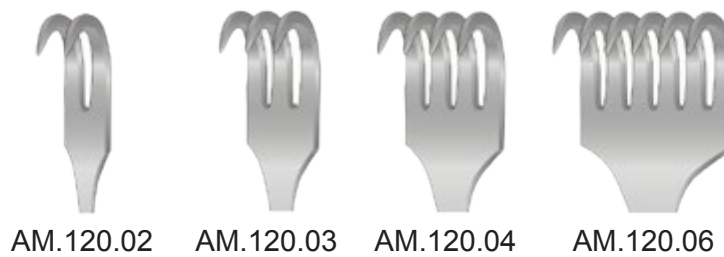
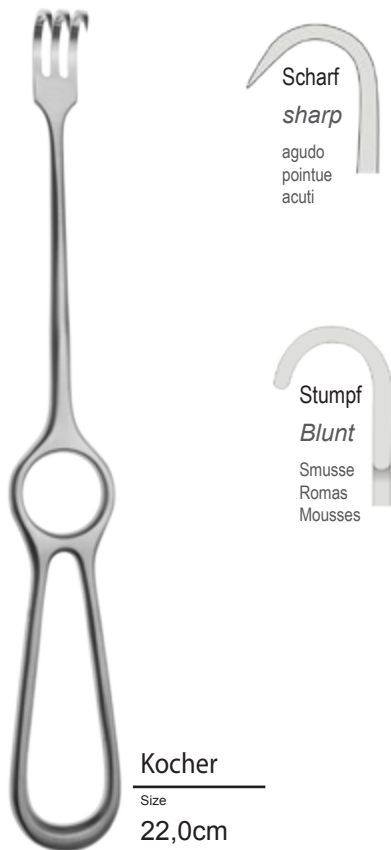
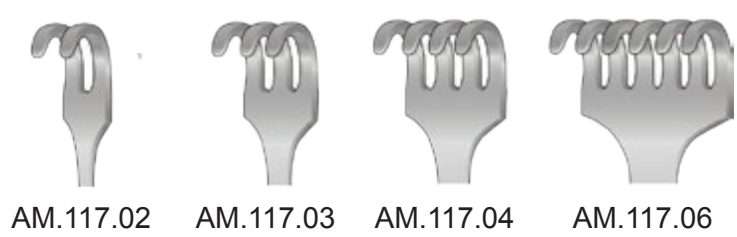
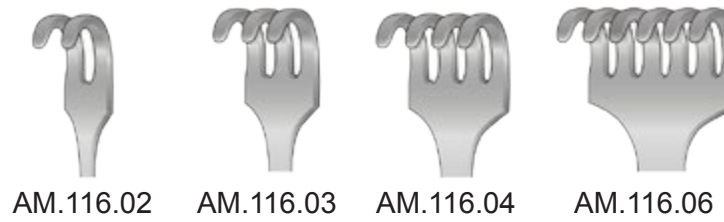
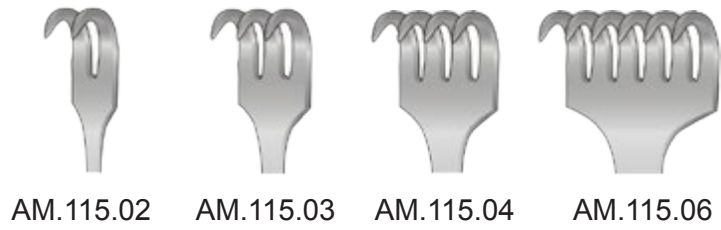
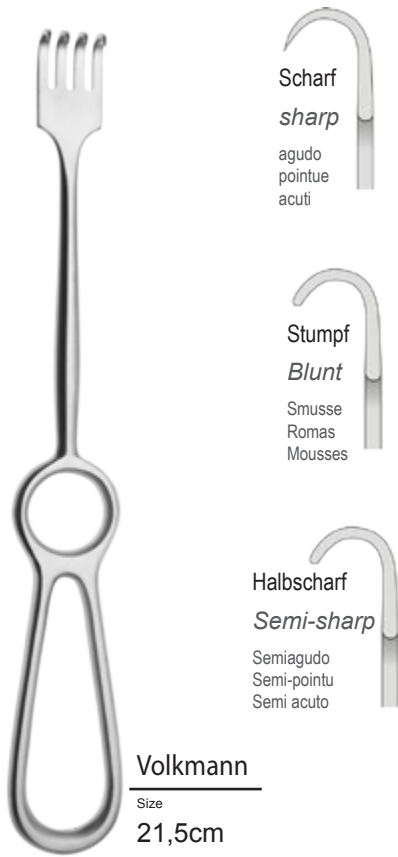

**WUNDHAKEN**  
**RETRACTORS**

SEPARADORES  
ECARTEURS  
DIVARICATORI

AM



Israel

Size

25,0cm



40x40mm  
AM.138.04



45x50mm  
AM.138.05

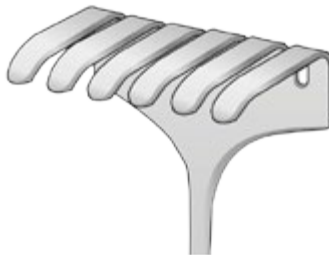

50x60mm  
AM.138.06



70x70mm  
AM.139.06



Langenbeck 22,0cm

Article No.	Size
AM.142.01	30x11mm
AM.142.02	30x14mm
AM.142.03	30x16mm
AM.142.04	40x11mm
AM.142.05	50x11mm



Langenbeck 21,0cm

Article No.	Size
AM.143.01	30x11mm
AM.143.02	30x14mm
AM.143.03	30x16mm
AM.143.04	40x11mm
AM.143.05	50x11mm
AM.143.06	40x13mm

**WUNDHAKEN  
RETRACTORS**

SEPARADORES  
ECARTEURS  
DIVARICATORI

AM

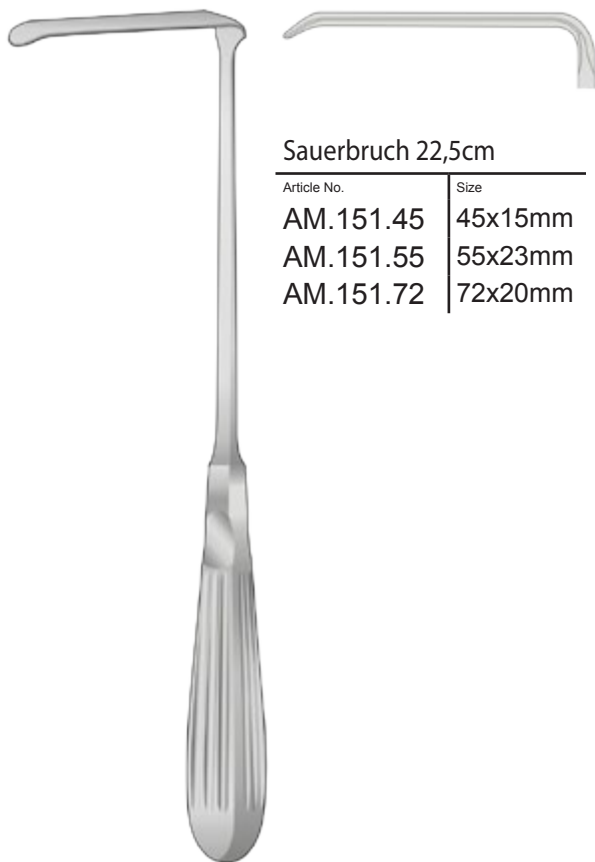

Sauerbruch 22,5cm

Article No.	Size
AM.151.45	45x15mm
AM.151.55	55x23mm
AM.151.72	72x20mm

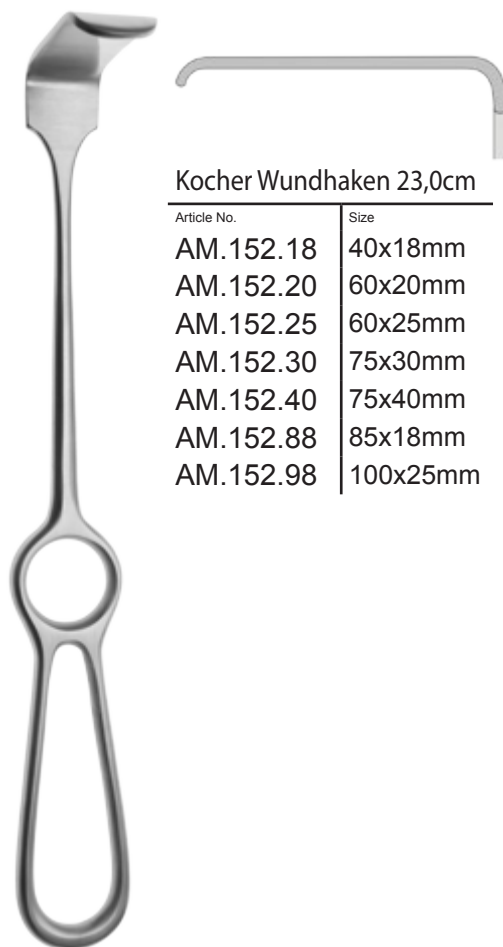

Kocher Wundhaken 23,0cm

Article No.	Size
AM.152.18	40x18mm
AM.152.20	60x20mm
AM.152.25	60x25mm
AM.152.30	75x30mm
AM.152.40	75x40mm
AM.152.88	85x18mm
AM.152.98	100x25mm

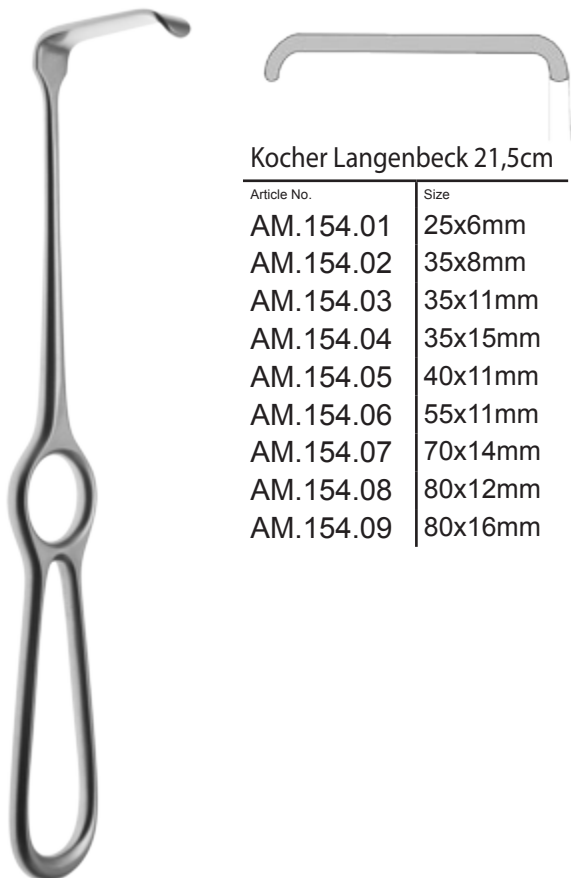

Kocher Langenbeck 21,5cm

Article No.	Size
AM.154.01	25x6mm
AM.154.02	35x8mm
AM.154.03	35x11mm
AM.154.04	35x15mm
AM.154.05	40x11mm
AM.154.06	55x11mm
AM.154.07	70x14mm
AM.154.08	80x12mm
AM.154.09	80x16mm





Obwegeser 22,0cm

Article No.	Size
AM.155.01	25x7mm
AM.155.02	31x10mm
AM.155.03	42x11mm
AM.155.04	55x12mm
AM.155.05	70x14mm
AM.155.07	80x16mm



Obwegeser 22,0cm

Article No.	Size
AM.155.11	25x7mm
AM.155.12	31x10mm
AM.155.13	42x11mm
AM.155.14	55x12mm
AM.155.15	70x14mm
AM.155.16	80x16mm

**WUNDHAKEN  
RETRACTORS**

SEPARADORES  
ECARTEURS  
DIVARICATORI

AM



**Middeldorpf**

Article No.	Size
AM.163.01	21,5cm   14x17mm
AM.163.02	22,0cm   20x22mm
AM.163.03	23,5cm   26x30mm



**Meyering**

Article No.	Size
AM.166.01	52x16mm
AM.166.02	76x25mm
AM.166.03	89x50mm



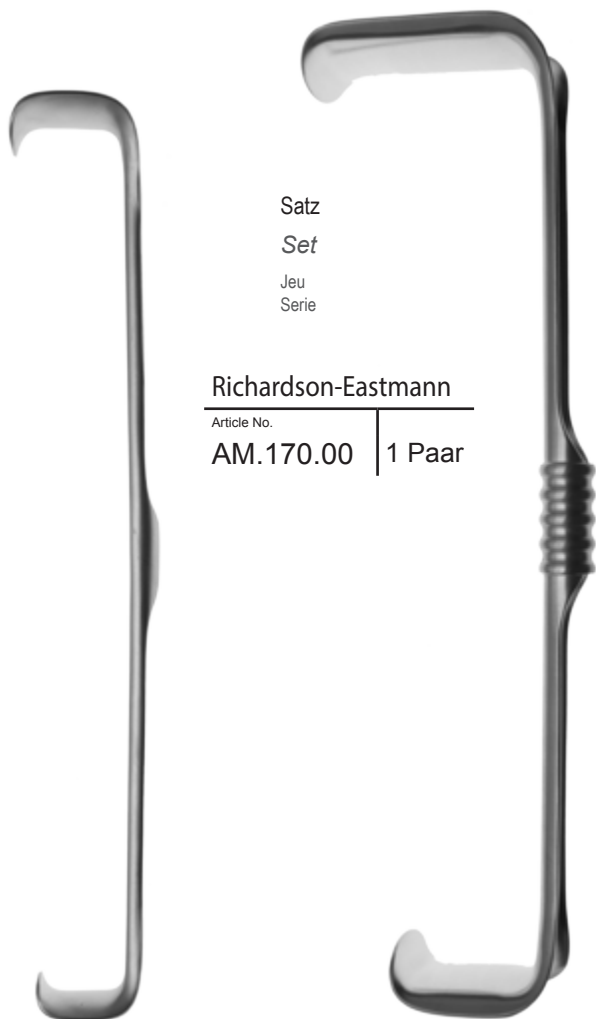

Satz  
 Set  
 Jeu  
 Serie

Richardson-Eastmann  
 Article No. AM.170.00 | 1 Paar



Richardson 24,0cm  
 Article No. AM.172.01 | Size 28x20mm  
 AM.172.02 | 38x28mm  
 AM.172.03 | 44x38mm

Richardson-Eastmann  
 25,0 cm

Article No.	Size
AM.170.01	28x20mm 36x28mm

Richardson-Eastmann  
 27,0 cm

Article No.	Size
AM.170.02	49x38mm 71x34mm

**WUNDHAKEN  
RETRACTORS**

SEPARADORES  
ECARTEURS  
DIVARICATORI

AM

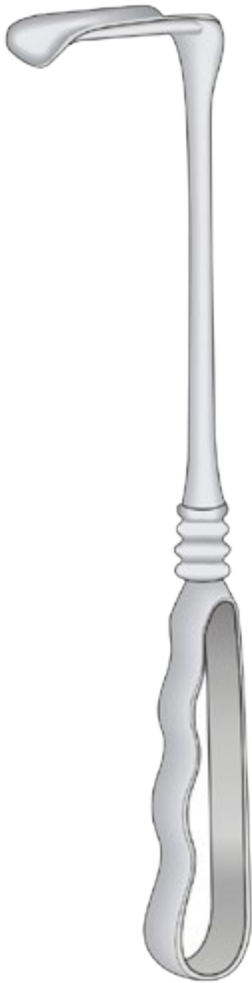

Richardson 26,0cm

Article No.	Size
AM.174.26	52x22mm

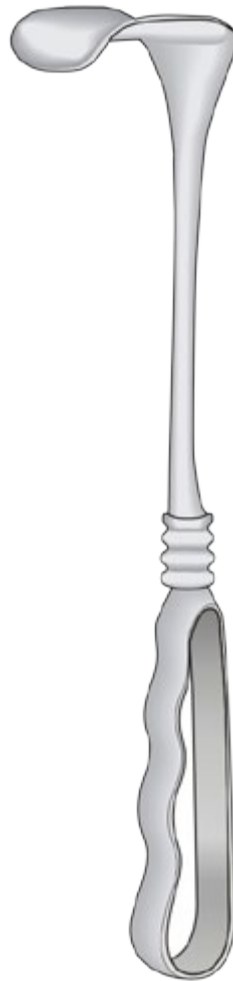

Kelly 26,0cm

Article No.	Size
AM.176.26	65x50mm

SEPARADORES  
ECARTEURS  
DIVARICATORI

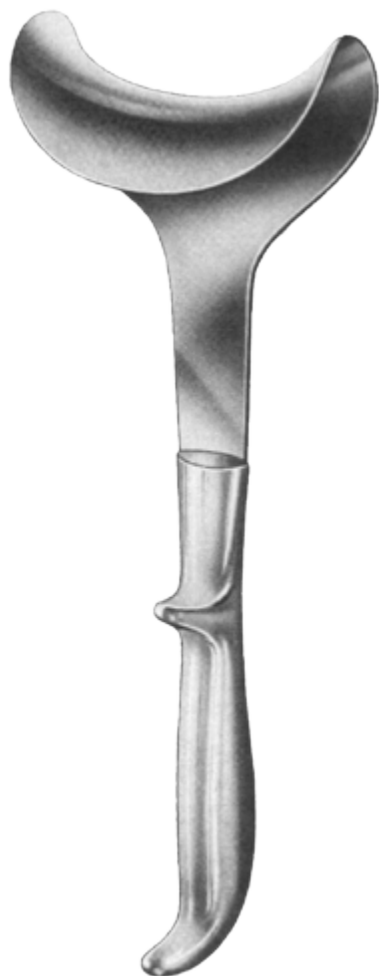

Doyen 25,0cm

Article No.	Size
AM.194.25	50x85mm

WUNDHAKEN  
RETRACTORS

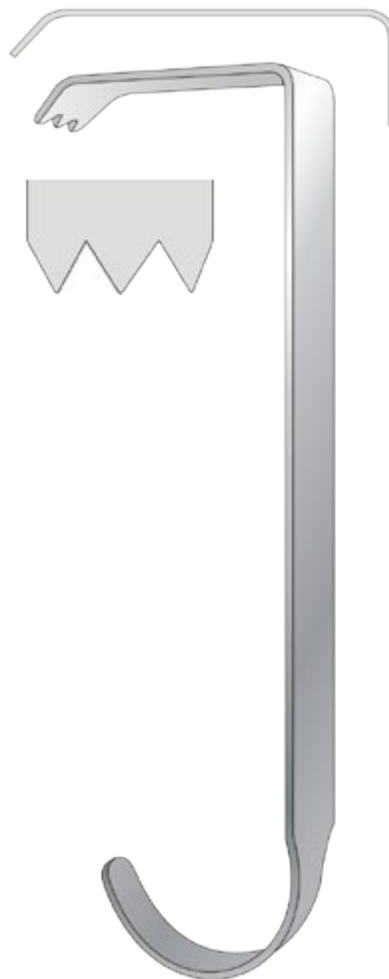

Hibbs 24,0cm

Article No.	Size
AM.196.75	25x75mm
AM.196.80	25x80mm

AM

**WUNDHAKEN  
RETRACTORS**

SEPARADORES  
ECARTEURS  
DIVARICATORI

AM

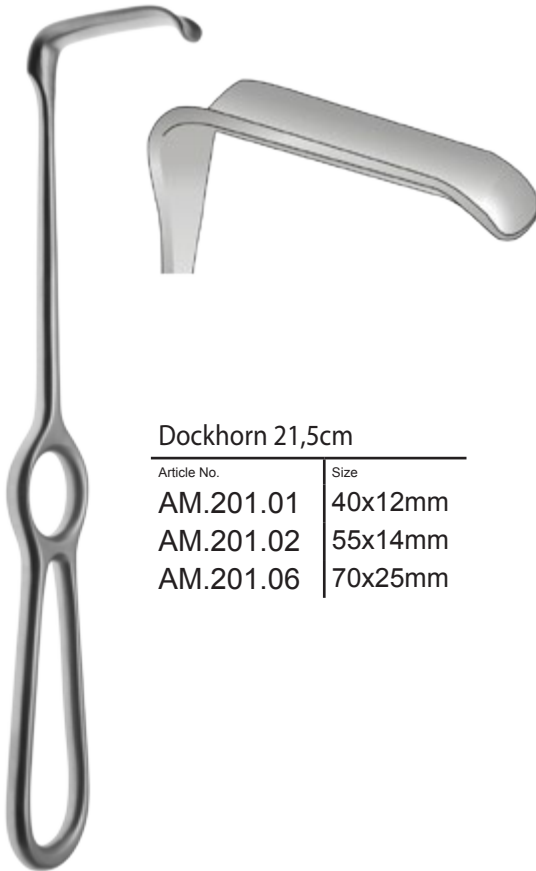

Dockhorn 21,5cm

Article No.	Size
AM.201.01	40x12mm
AM.201.02	55x14mm
AM.201.06	70x25mm

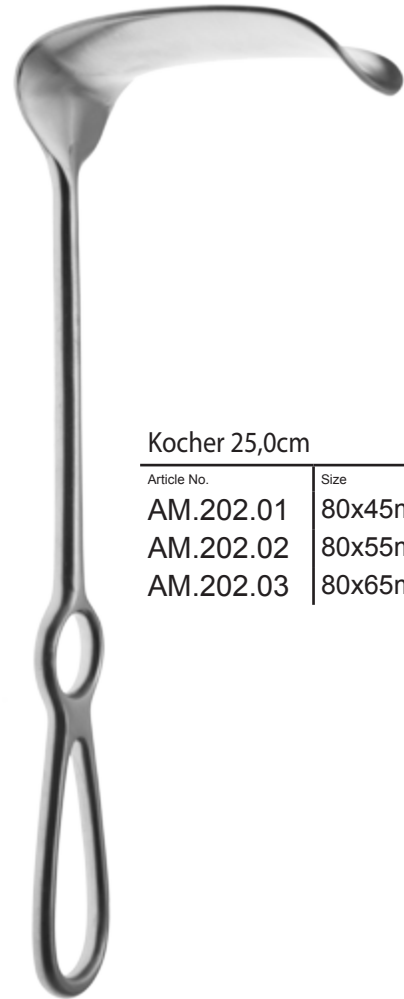

Kocher 25,0cm

Article No.	Size
AM.202.01	80x45mm
AM.202.02	80x55mm
AM.202.03	80x65mm

SEPARADORES  
ECARTEURS  
DIVARICATORI

WUNDHAKEN  
RETRACTORS

AM

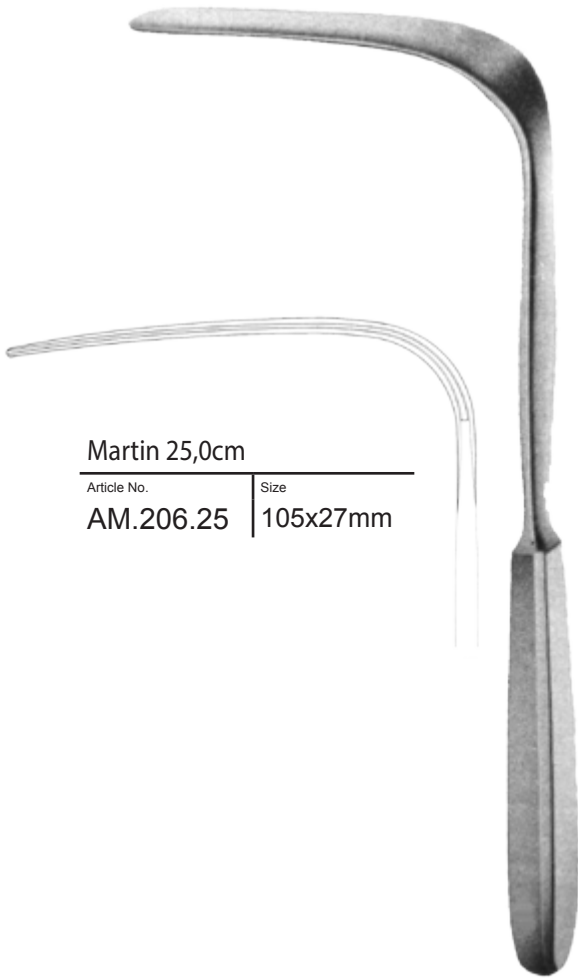

Martin 25,0cm

Article No.	Size
AM.206.25	105x27mm



Simon 28,0cm

Article No.	Size
AM.208.28	115x27mm
AM.209.28	115x22mm

**WUNDHAKEN  
RETRACTORS**

SEPARADORES  
ECARTEURS  
DIVARICATORI

**AM**



Coryllos 24cm

Article No.	Size
AM.214.03	115x65mm

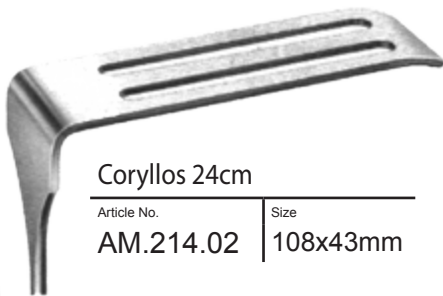

Coryllos 24cm

Article No.	Size
AM.214.02	108x43mm



Coryllos 24cm

Article No.	Size
AM.214.01	82x22mm

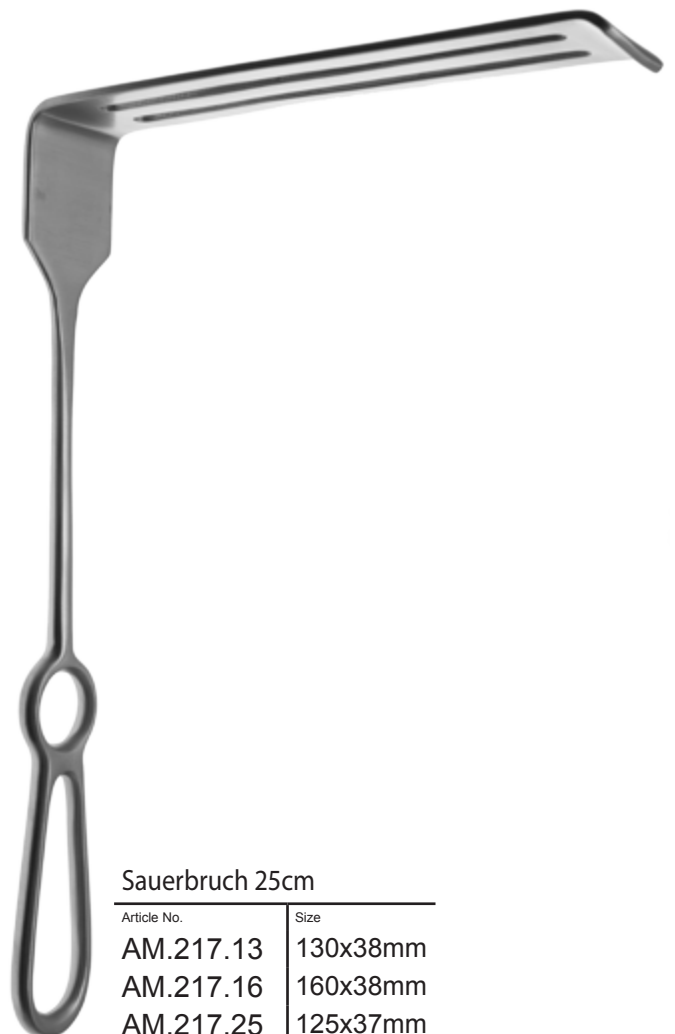

Sauerbruch 25cm

Article No.	Size
AM.217.13	130x38mm
AM.217.16	160x38mm
AM.217.25	125x37mm



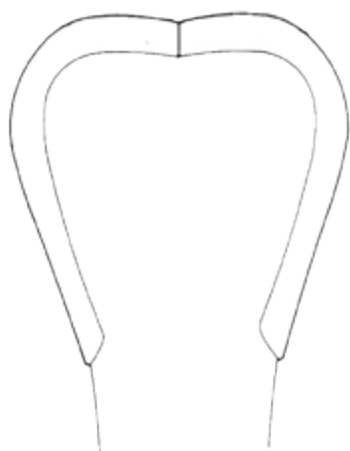

Harrington 32cm

Article No.	Size
AM.233.01	127x40mm

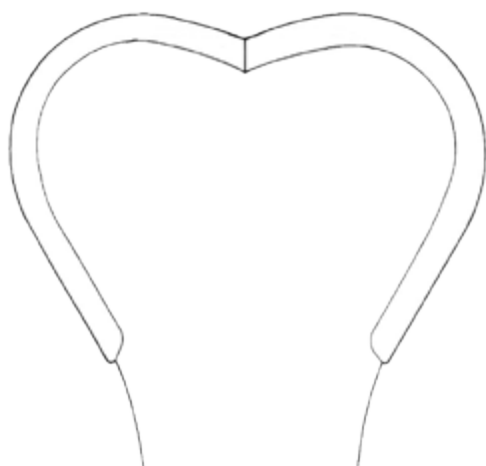

Harrington 32cm

Article No.	Size
AM.233.02	127x62mm



**WUNDHAKEN**  
**RETRACTORS**

SEPARADORES  
ECARTEURS  
DIVARICATORI

**AM**



Deaver 19,0cm

Article No.	Size
AM.236.01	19mm



Deaver 30,0cm

Article No.	Size
AM.236.04	25mm



Deaver 21,5cm

Article No.	Size
AM.236.02	22mm



Deaver 23,0cm

Article No.	Size
AM.236.03	25mm



Deaver 33,0cm

Article No.	Size
AM.236.05	25mm



Deaver 30,0cm

Article No.	Size
AM.236.07	38mm

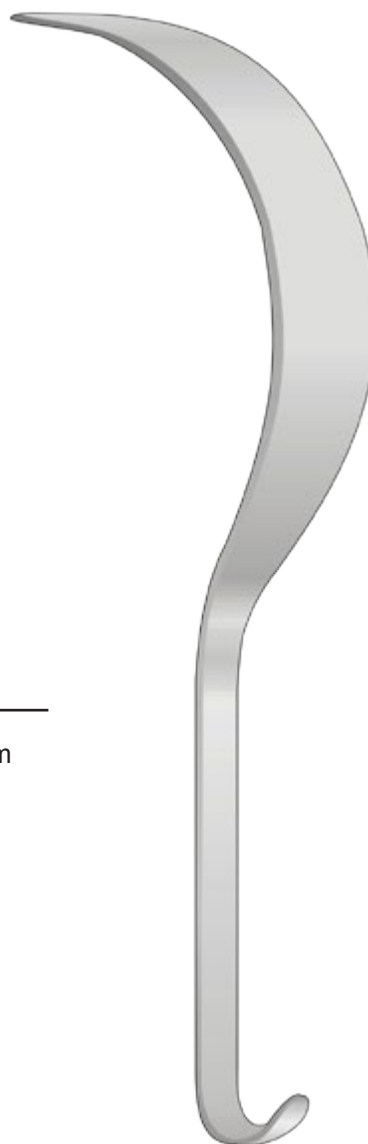

Deaver 30,0cm

Article No.	Size
AM.236.09	75mm

Deaver 36,0cm

Article No.	Size
AM.236.06	25mm

Deaver 30,0cm

Article No.	Size
AM.236.08	50mm

**AM**

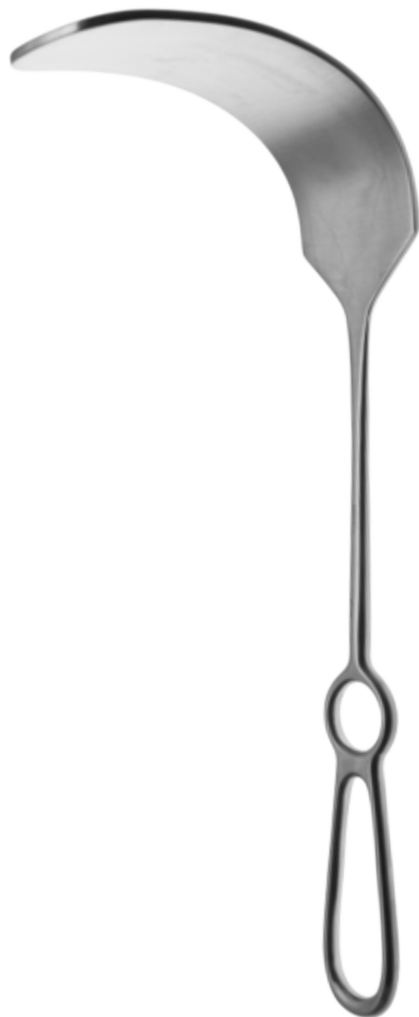

Mikulicz 26,0cm

Article No.	Size
AM.248.01	90x35mm
AM.248.02	120x50mm
AM.248.03	150x50mm



Kelly 27,0cm

Article No.	Size
AM.254.01	190x38mm
AM.254.02	190x57mm
AM.255.38	160x38mm
AM.255.57	160x57mm



Roux

Article No.	Size
AM.280.00	Set / 3 Stück
AM.280.01	Figur 1
AM.280.02	Figur 2
AM.280.03	Figur 3
AM.280.04	Figur 3

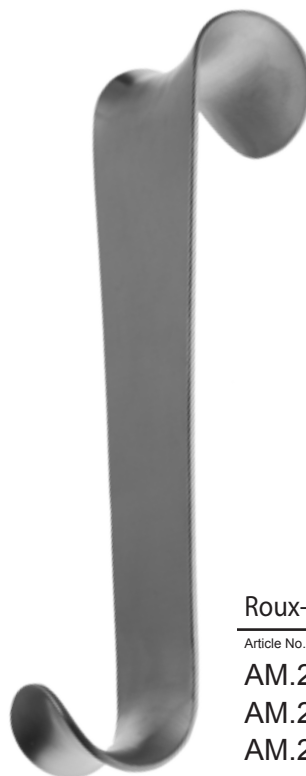

Roux-Magnus

Article No.	Size
AM.281.01	20x22 / 25x28mm
AM.281.02	23x26 / 29x38mm
AM.281.03	29x29 / 34x44mm



Farabeuf

Article No.	Size
AM.284.12	12cm
AM.284.15	15cm

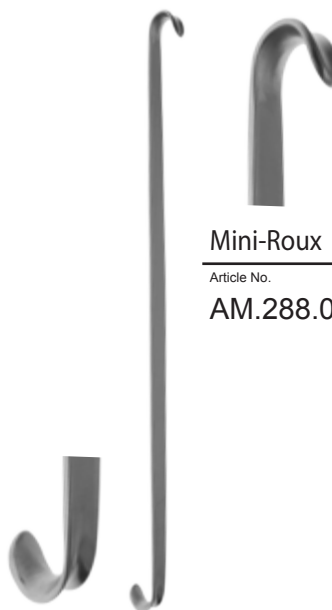

Mini-Roux

Article No.	Size
AM.288.06	14cm

**WUNDHAKEN  
RETRACTORS**

SEPARADORES  
ECARTEURS  
DIVARICATORI

**AM**



Baby-Roux 13cm

Article No.	Size
AM.289.13	18x17 24x21mm



Roux 16cm

Article No.	Size
AM.289.16	28x23 / 43x23mm



Roux 18,5cm

Article No.	Size
AM.289.19	28x27 / 45x27mm



Parker 13,5cm

Article No.	Size
AM.292.13	



Parker 18cm

Article No.	Size
AM.292.18	



Parker-Mott 16cm

Article No.	Size
AM.296.00	



Mathieu

Article No.	Size
AM.298.00	20,0cm



Parker-Langenbeck

Article No.	Size
AM.300.00	21,0cm



Goelet

Article No.	Size
AM.302.00	19,0cm

# WUNDSPREIZER SELF-RETAINING RETRACTORS

SEPARADORES AUTOSTÁTICOS  
ECARTEURS  
DIVARICATORI

AM



Scharf  
*sharp*  
agudo  
pointue  
acuti

Finsen Zähne: 3/2

Article No.	Size
AM.401.05	5cm

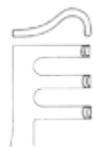

Stumpf  
*Blunt*  
Smusse  
Romas  
Mousses

Finsen Zähne: 3/2

Article No.	Size
AM.402.05	5cm



Scharf  
*sharp*  
agudo  
pointue  
acuti

Finsen Zähne: 4/3

Article No.	Size
AM.401.07	7cm



Stumpf  
*Blunt*  
Smusse  
Romas  
Mousses

Finsen Zähne: 4/3

Article No.	Size
AM.402.07	7cm



Scharf  
*sharp*  
agudo  
pointue  
acuti

Finsen Zähne: 4/3

Article No.	Size
AM.403.07	7cm



Stumpf  
*Blunt*  
Smusse  
Romas  
Mousses

Finsen Zähne: 4/3

Article No.	Size
AM.404.07	7cm



Scharf  
*sharp*  
agudo  
pointue  
acuti

Holzheimer

Article No.	Size
AM.420.10	10cm



Stumpf  
*Blunt*  
Smusse  
Romas  
Mousses

Holzheimer

Article No.	Size
AM.421.10	10cm



Alm 7cm

Article No.	Size
AM.414.07	scharf
AM.415.07	halbscharf
AM.416.07	stumpf

Alm 10cm

Article No.	Size
AM.414.10	scharf
AM.415.10	halbscharf
AM.416.10	stumpf



AM

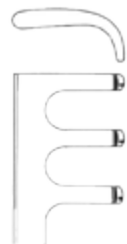

Jansen 10cm

Article No.	Size
AM.424.10	scharf
AM.426.10	stumpf

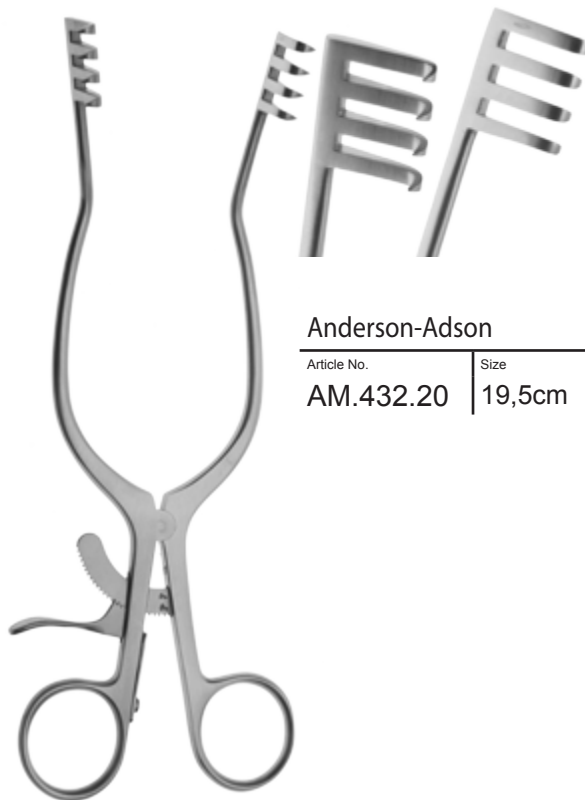

Anderson-Adson

Article No.	Size
AM.432.20	19,5cm



Spitz  
 Sharp

Acute  
 Agudas  
 Pointus

Weitlaner

Article No.	Size
AM.442.10	10,5cm

Stumpf  
 Blunt

Smusse  
 Romas  
 Mousses

Weitlaner

Article No.	Size
AM.443.10	10,5cm

Spitz

Sharp

Acute  
 Agudas  
 Pointus

Weitlaner

Article No.	Size
AM.442.14	14cm
AM.442.16	16cm
AM.442.20	20cm

Stumpf

Blunt

Smusse  
 Romas  
 Mousses

Weitlaner

Article No.	Size
AM.443.14	14cm
AM.443.16	16cm
AM.443.20	20cm

**WUNDSPREIZER**  
**SELF-RETAINING RETRACTORS**

SEPARADORES AUTOSTÁTICOS  
 ECARTEURS  
 DIVARICATORI

**AM**



Spitz  
*Sharp*

Acute  
 Agudas  
 Pointus

Plester

Article No.	Size
AM.452.13	13cm

Stumpf  
*Blunt*

Smusse  
 Romas  
 Mousses

Plester

Article No.	Size
AM.453.13	13cm



Plester

Article No.	Size
AM.456.11	11cm



Plester

Article No.	Size
AM.457.11	11cm



Adson stumpf 5x6 Zähne

Article No.	Size
AM.464.56	29,5cm



Beckmann 4x4 Zähne

Article No.	Size
AM.475.31	31cm



Beckmann Eaton 7x7 Zähne spitz

Article No.	Size
AM.480.33	32cm

**WUNDSPREIZER**  
**SELF-RETAINING RETRACTORS**

SEPARADORES AUTOSTÁTICOS  
ECARTEURS  
DIVARICATORI

**AM**



Gelpi-Loktite

Article No.	Size
AM.490.13	13cm



Gelpi-Loktite

Article No.	Size
AM.490.18	18cm



Gelpi-Loktite

Article No.	Size
AM.491.18	18cm

SEPARADORES ABDOMINALES  
ECARTEURS À PARI ABDOMINALE  
DIVARICATORI ADDOMINALI

## BAUCHDECKENHALTER ABDOMINAL RETRACTOR

AM



Collin Bauchdeckenhalter  
komplett

Article No.	Size
AM.524.00	22cm

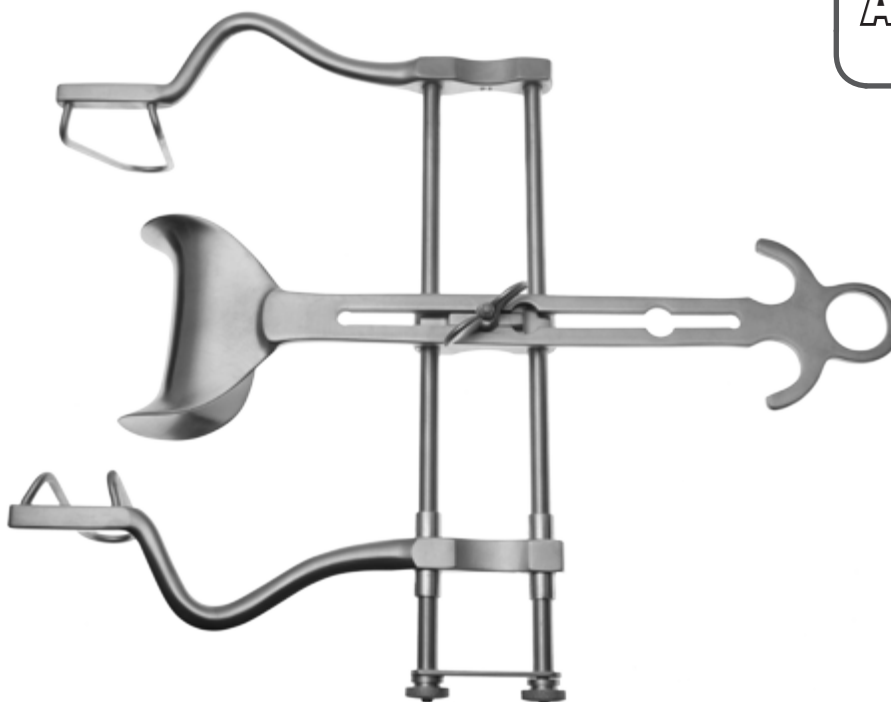

Holzbach Wundspreizer  
komplett

Article No.	Size
AM.528.00	27,5cm

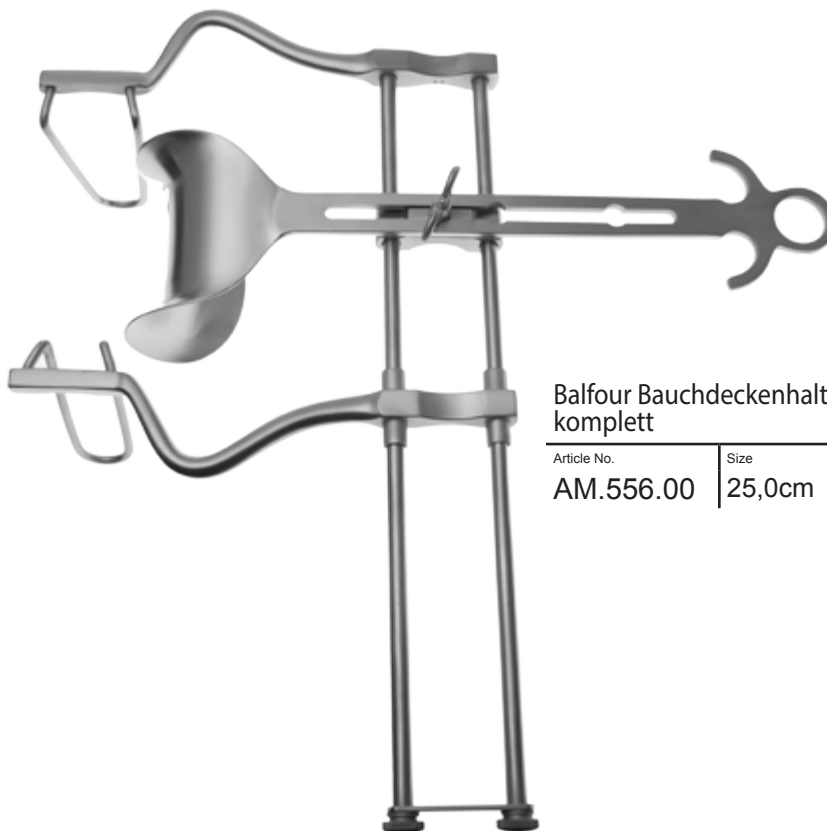

Balfour Bauchdeckenhalter  
komplett

Article No.	Size
AM.556.00	25,0cm

# BAUCHDECKENHALTER ABDOMINAL RETRACTOR

SEPARADORES ABDOMINALES  
ECARTEURS À PARI ABDOMINALE  
DIVARICATORI ADDOMINALI

AM

Starr  
rigid frame

cuadro fijo  
cadre bombé fixe  
Divaricatore solo fisso

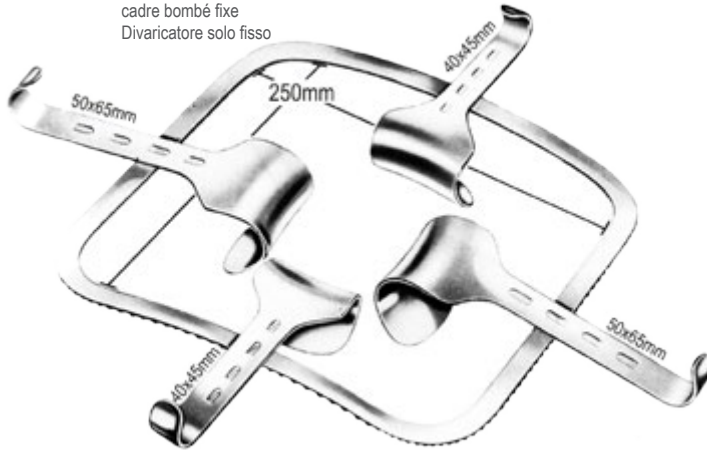

Kirschner Rahmen

Article No.	Size
AM.590.00	komplett

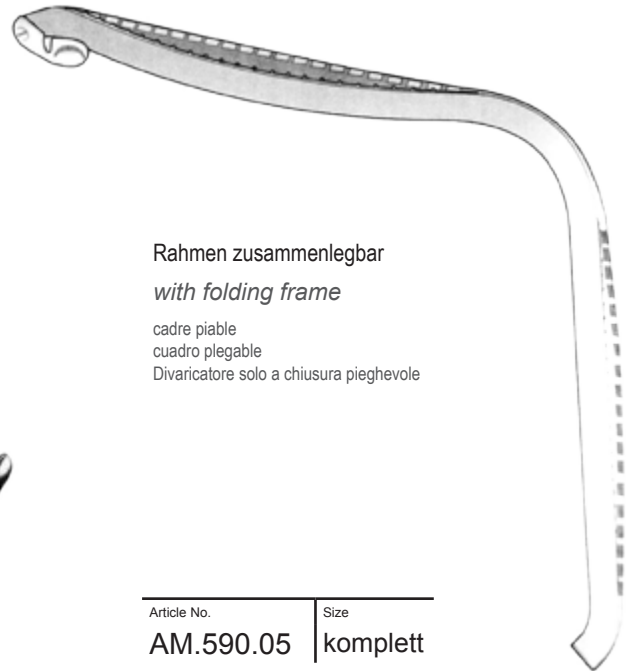

Rahmen zusammenlegbar  
with folding frame

cadre pliable  
cuadro plegable  
Divaricatore solo a chiusura pieghevole

Article No.	Size
AM.590.05	komplett



Kirschner

Article No.	Size
AM.590.40	40x55mm
AM.590.50	50x65mm
AM.590.60	60x85mm
AM.590.65	65x80mm
AM.590.70	78x65mm
AM.590.80	80x80mm
AM.590.84	80x90mm
AM.590.88	90x65mm
AM.590.90	90x90mm
AM.590.92	108x42mm



**Stille-Gipsschere**

Article No.	Size
AO.100.23	23,0cm
AO.100.26	26,0cm
AO.100.37	37,0cm

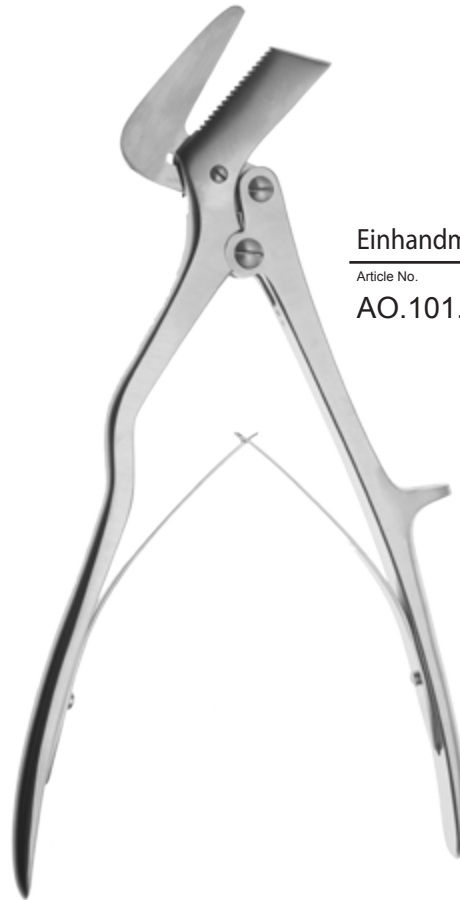

**Einhandmodell**

Article No.	Size
AO.101.24	24,0cm

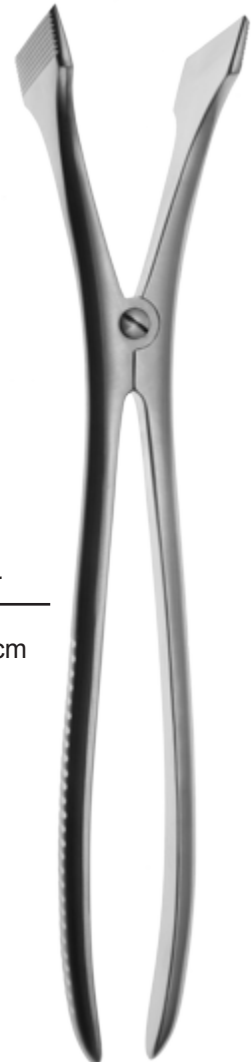

**Engel Gipssäge**

Article No.	Size
AO.120.14	14,0cm

**Henning Gipsspreizer**

Article No.	Size
AO.210.28	28,0cm

**GIPSINSTRUMENTE**  
**PLASTER CAST INSTRUMENTS**

INSTROMENTOS PARA VENDAJES ENYESADOS  
PINCES POUR LES APPAREILS PLÂTRÉS  
STRUMENTI PER APPARECCHI GESSATI

AO



**Haglund**

Article No.	Size
AO.212.18	28,0cm



**USA-Modell**

Article No.	Size
AO.220.23	23,0cm



**Wolf**

Article No.	Size
AO.230.18	18,0cm
AO.230.24	24,0cm





gerade

Article No.	Size
AP.104.09	9cm
AP.104.10	10cm

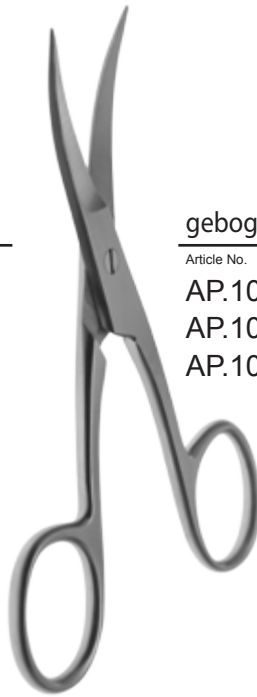

gebogen

Article No.	Size
AP.105.09	9cm
AP.105.10	10cm
AP.105.11	11cm

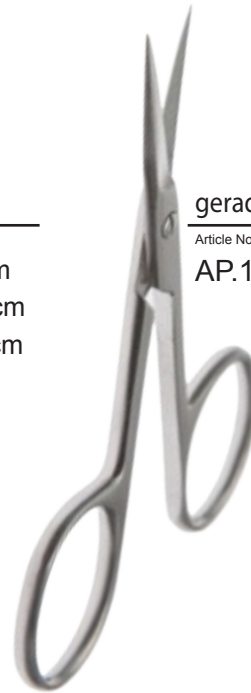

gerade, schlank

Article No.	Size
AP.109.19	9cm

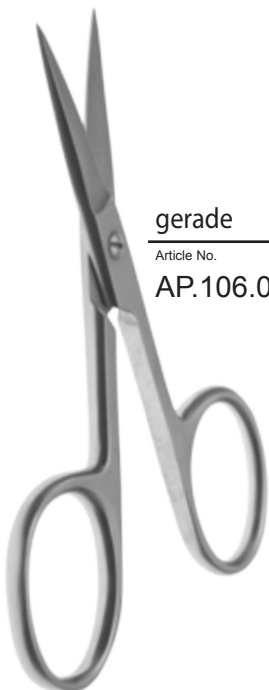

gerade

Article No.	Size
AP.106.09	9cm



gebogen, verjüngt

Article No.	Size
AP.106.10	10cm



gebogen

Article No.	Size
AP.107.09	9cm
AP.107.10	10cm

# NAGELSCHEREN NAIL SCISSORS

TIJERAS  
CISEAUX  
FORBICI

AP



## Nagelpflegeset Nail care set

Article No.	
AP.100.02	Schere, Feile
AP.100.03	Schere, Feile, Zange
AP.100.04	Schere, Feile, Zange, Knipser
AP.100.12	Schere, Zange



### Baby Nagelschere

Article No.	Size
AP.111.08	8,5cm



### Nagelzange ergonomisch

Article No.	Size
AP.115.18	18,0cm

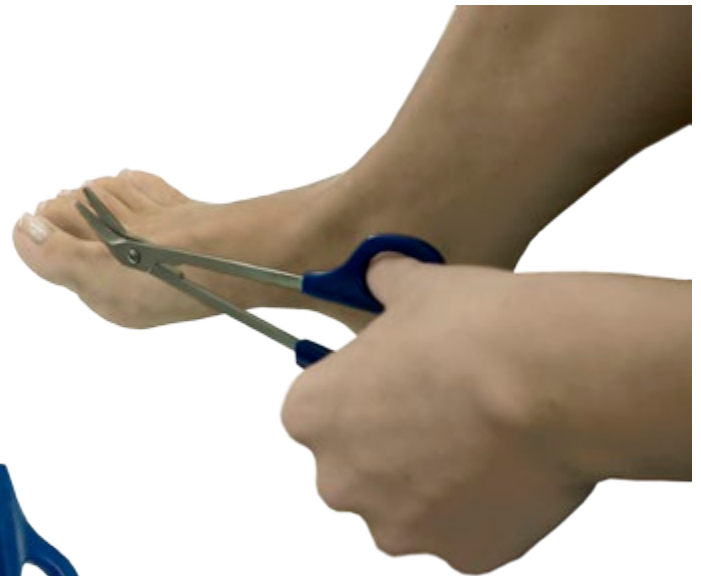



Nagelzange konkav

Article No.	Size
AP.118.13	13,0cm



Kopfschneider

Article No.	Size
AP.120.14	14,0cm



Nagelzange  
 22mm Schneide

Article No.	Size
AP.124.14	14,0cm
AP.124.16	16,0cm



Nagelzange

Article No.	Size
AP.136.12	12,0cm



Nagelzange spitz

Article No.	Size
AP.140.11	11,0cm
AP.140.13	13,0cm
AP.140.15	15,0cm

**NAGELZANGEN**  
**NAIL NIPPERS**

PINZAS CONTAUNAS  
PINCES À ONGLES  
TRONCHESINE PER UNGHIE

AP



Nagelzange doppeltüber-  
setzt - klein

Article No.	Size
APZ.128.12	12,0cm



Nagelzange doppeltüber-  
setzt - gebogen

Article No.	Size
APZ.128.15	15,0cm



Nagelzange doppeltüber-  
setzt - gerade

Article No.	Size
APZ.128.55	15,0cm



Nagelzange doppeltübersetzt -  
kopfschneider

Article No.	Size
AP.130.15	15,0cm

PINZAS CONTAUNAS  
PINCES À ONGLES  
TRONCHESINE PER UNGHIE

## NAGELZANGEN NAIL NIPPERS

AP



Nagelzange

Article No.	Size
APZ.124.14	14,0cm



Für Diabetiker  
For Diabetic

Nagelzange - kopfschneiden

Article No.	Size
AP.125.14	14,0cm



Nagelhautzange

Article No.	Size
AP.153.10	10,0cm

**NAGELFEILE**  
**NAIL FILE**

LIMA DE U'NAS  
LIME À ONGLES  
LIMA PER UNGHIE

AP



Nagelfeile

Article No.	Size
AP.180.10	10,0cm



in zwei Farben  
two different colors

Glasfeile

Article No.	Size
AP.188.04	13,0cm

Hornhautmesser

Article No.	Size
AP.198.01	18,5cm



rund/lanzette



Saalfeld Komedonenquetscher

Article No.	Size
AP.206.10	10,0cm



Saalfeld Komedonenquetscher

Article No.	Size
AP.208.14	14,0cm

oval/oval



Una Komedonenquetscher

Article No.	Size
AP.202.14	14,0cm

rund/rund



Una Komedonenquetscher

Article No.	Size
AP.204.14	14,0cm



Schamberg Komedonenquetscher

Article No.	Size
AP.210.10	10cm
AP.210.20	10cm schmal/narrow



Katsch Komedonenquetscher

Article No.	Size
AP.220.14	14,0cm

AP



Fox Lupuskürette, rund

Article No.	Size
AP.300.02	Ø2mm/14cm
AP.300.03	Ø3mm/14cm
AP.300.04	Ø4mm/14cm
AP.300.05	Ø5mm/14cm
AP.300.06	Ø6mm/14cm



Fox Lupuskürette, oval

Article No.	Size
AP.301.02	Ø2mm/14cm
AP.301.03	Ø3mm/14cm
AP.301.04	Ø4mm/14cm
AP.301.05	Ø5mm/14cm
AP.301.06	Ø6mm/14cm



Piffard Kürette, oval, 14cm

Article No.	Size
AP.306.01	Fig 1/Ø3mm
AP.306.02	Fig 2/Ø5mm
AP.306.03	Fig 3/Ø6mm
AP.306.04	Fig 4/Ø8mm
AP.306.05	Fig 5/Ø10mm



Zur Brustwarzenentfernung

Mamillenschneider

Article No.	Size
AP.350.32	Ø32mm
AP.350.37	Ø37mm
AP.350.38	Ø38mm
AP.350.40	Ø40mm
AP.350.42	Ø42mm
AP.350.43	Ø43mm
AP.350.45	Ø45mm
AP.350.50	Ø50mm
AP.350.55	Ø55mm





Keys Haut-  
stanzen Set

Article No.  
AP.340.00

Satz komplett  
*Set complete*

Juego completo  
Jeu complét



Handle only

Griffalleine

Article No.  
AP.340.50



Einsatz alleine

Article No.	Size
AP.340.52	2mm
AP.340.53	3mm
AP.340.54	4mm
AP.340.55	5mm
AP.340.56	6mm
AP.340.57	7mm

Keys 9,5cm

Article No.	Size
AP.340.02	2mm
AP.340.03	3mm
AP.340.04	4mm
AP.340.05	5mm
AP.340.06	6mm
AP.340.07	7mm
AP.340.08	8mm
AP.340.10	10mm
AP.340.12	12mm
AP.340.14	14mm
AP.340.16	16mm



Keys 90° 8,5cm

Article No.	Size
AP.341.02	2mm
AP.341.03	3mm
AP.341.04	4mm
AP.341.05	5mm
AP.341.06	6mm
AP.341.07	7mm
AP.341.08	8mm

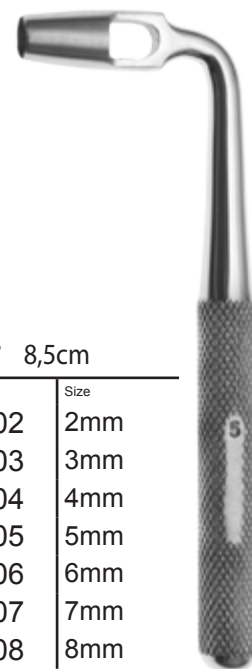

# FINGERRINGSÄGEN

## INSTRUMENTS FOR FINGER AND TOES

INSTRUMENTS Á ONGLES  
STRUMENTI PER UNGHIE

AP



Fingerringssagen  
Finger ring saw  
Sierras para cortar anillos  
Scies pour bagues  
Seghe per anelli

Article No.	Size
AP.404.17	17,0cm



Walton mit Druckbügel

Article No.	Size
AP.405.16	16,0cm

Sägeblatt alleine  
Saw blade only



Mit Seitenbacken

Article No.	Size
AP.404.98	Ø30mm



Ohne Seitenbacken

Article No.	Size
AP.404.99	Ø30mm



Fr Walton Sägeblatt

Article No.	Size
AP.405.98	Ø22mm



Radolf

Article No.	Size
AP.410.13	13,0cm



Nagelrausreißzange

Article No.	Size
AP.412.14	14,5cm

Finger und Zehenkompressorium mit Metallband

*Torniquet for fingers and toes, with metal strap*



Feldheim

Article No.	Size
AP.420.10	10,0cm

**UNTERSUCHUNGSHAMMER**  
**DIAGNOSTICS HAMMER**

DIAGNOSTICO  
DIAGNOSTIC  
DIAGNOSTICA

AR



Buck  
Perkussionshammer

Article No.	Size
AR.100.18	18,0cm



Troemmer  
Perkussionshammer

Article No.	Size
AR.115.24	24,0cm



Dejerine  
Reflexhammer m. Nadel

Article No.	Size
AR.122.21	21,0cm



Berliner  
Perkussionshammer

Article No.	Size
AR.135.20	20,0cm



Osher Zirkel

Article No.	Size
AR.301.01	0-10mm



Jameson

Article No.	Size
AR.301.02	0-80mm



Thorpe

Article No.	Size
AR.301.03	0-80mm



Townley

Article No.	Size
AR.301.05	0-100mm

AR

Dynamometer  
Dynamometer  
Dinamómetro  
Dynamomètre  
Dinamometro



Collin für Erwachsene

Article No.	Size
AR.320.01	

Collin für Kinder

Article No.	Size
AR.320.02	

Winkelmesser  
Goniometer  
Goniómetro  
Goniomètre  
Goniometro

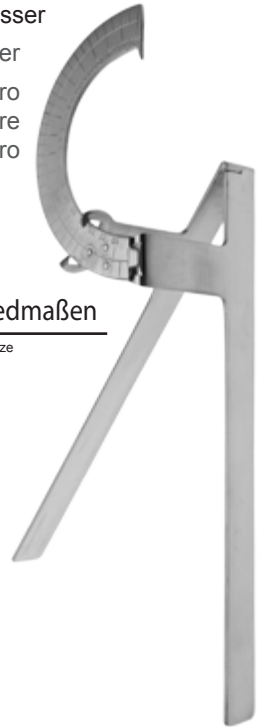

Moeltgen für Gliedmaßen

Article No.	Size
AR.350.01	



Caroll Finger Goniometer  
180°

Article No.	Size
AR.360.12	15 ,0cm

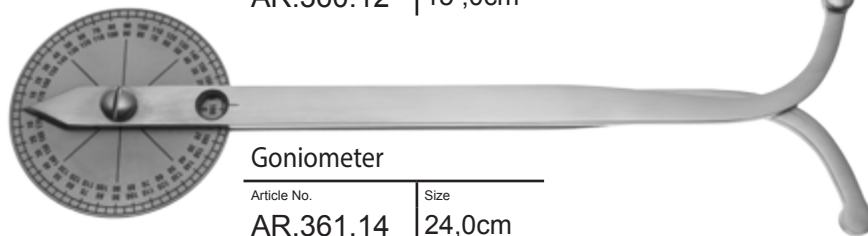

Goniometer

Article No.	Size
AR.361.14	24,0cm

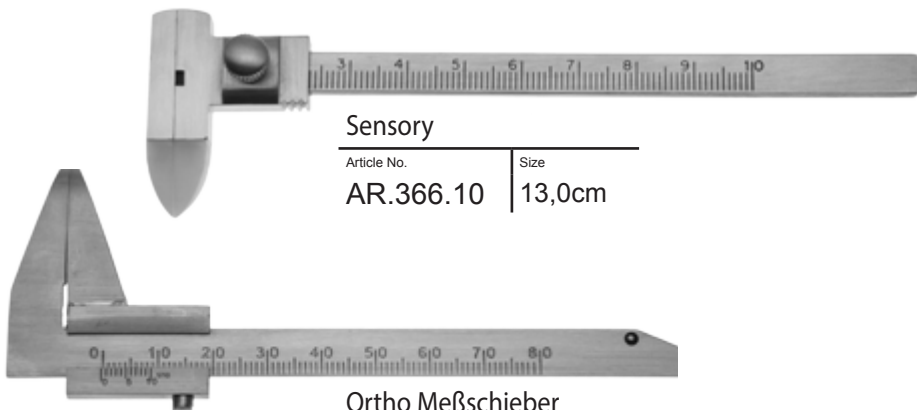

Sensory

Article No.	Size
AR.366.10	13,0cm

Ortho Meßschieber

Article No.	Size
AR.367.12	12,5cm

REDON AGUJAS DE GUIA  
REDON AIGILLES D'INTRODUCTION  
REDON AGHI PER INTRODUZIONE

## REDON FÜHRUNGSNADELN REDON GUIDE NEEDLE

AS



Stufenansatz  
*Step Formation*

Messerspitze gerade  
*Knife point straight*

Article No.	Charr.
AS.410.06	6
AS.410.08	8
AS.410.10	10
AS.410.12	12
AS.410.14	14
AS.410.16	16
AS.410.18	18



Gewindeansatz  
*Pitch of a  
Screw*

Messerspitze gerade  
*Knife point straight*

Article No.	Charr.
AS.412.06	6
AS.412.08	8
AS.412.10	10
AS.412.12	12
AS.412.14	14
AS.412.16	16
AS.412.18	18



# REDON FÜHRUNGSNADELN

## REDON GUIDE NEEDLE

REDON AGUJAS DE GUIA  
REDON AIGILLES D'INTRODUCTION  
REDON AGHI PER INTRODUZIONE

AS



Stufenansatz  
*Step Formation*

Messerspitze gebogen

*Knife point curved*

Article No.	Charr.
AS.416.08	8
AS.416.10	10
AS.416.12	12
AS.416.14	14
AS.416.16	16
AS.416.18	18



Gewindeansatz  
*Pitch of a  
Screw*

Messerspitze gebogen

*Knife point curved*

Article No.	Charr.
AS.418.08	8
AS.418.10	10
AS.418.12	12
AS.418.14	14
AS.418.16	16
AS.418.18	18





REDON AGUJAS DE GUIA  
REDON AIGILLES D'INTRODUCTION  
REDON AGHI PER INTRODUZIONE

## REDON FÜHRUNGSNADELN REDON GUIDE NEEDLE

AS



Stufenansatz  
*Step Formation*

Lanzettspitze gerade  
*Lancet point straight*

Article No.	Charr.
AS.420.06	6
AS.420.08	8
AS.420.10	10
AS.420.12	12
AS.420.14	14
AS.420.16	16
AS.420.18	18



Gewindeansatz  
*Pitch of a  
Screw*

Lanzettspitze gerade  
*Lancet point straight*

Article No.	Charr.
AS.422.06	6
AS.422.08	8
AS.422.10	10
AS.422.12	12
AS.422.14	14
AS.422.16	16
AS.422.18	18



# REDON FÜHRUNGSNADELN

## REDON GUIDE NEEDLE

REDON AGUJAS DE GUIA  
REDON AIGILLES D'INTRODUCTION  
REDON AGHI PER INTRODUZIONE

AS



Stufenansatz  
*Step Formation*

Lanzettspitze gebogen  
*Lancet point curved*

Article No.	Charr.
AS.426.08	8
AS.426.10	10
AS.426.12	12
AS.426.14	14
AS.426.16	16
AS.426.18	18



Gewindeansatz  
*Pitch of a Screw*

Lanzettspitze gebogen  
*Lancet point curved*

Article No.	Charr.
AS.428.08	8
AS.428.10	10
AS.428.12	12
AS.428.14	14
AS.428.16	16
AS.428.18	18



REDON AGUJAS DE GUIA  
REDON AIGILLES D'INTRODUCTION  
REDON AGHI PER INTRODUZIONE

## REDON FÜHRUNGSNADELN REDON GUIDE NEEDLE

AS



Stufenansatz  
*Step Formation*

Trokarspitze gerade  
*Trocar point straight*

Article No.	Charr.
AS.430.06	6
AS.430.08	8
AS.430.10	10
AS.430.12	12
AS.430.14	14
AS.430.16	16
AS.430.18	18



Gewindeansatz  
*Pitch of a  
Screw*

Trokarspitze gerade  
*Trocar point straight*

Article No.	Charr.
AS.432.06	6
AS.432.08	8
AS.432.10	10
AS.432.12	12
AS.432.14	14
AS.432.16	16
AS.432.18	18



# REDON FÜHRUNGSNADELN

## REDON GUIDE NEEDLE

REDON AGUJAS DE GUIA  
REDON AIGILLES D'INTRODUCTION  
REDON AGHI PER INTRODUZIONE

AS

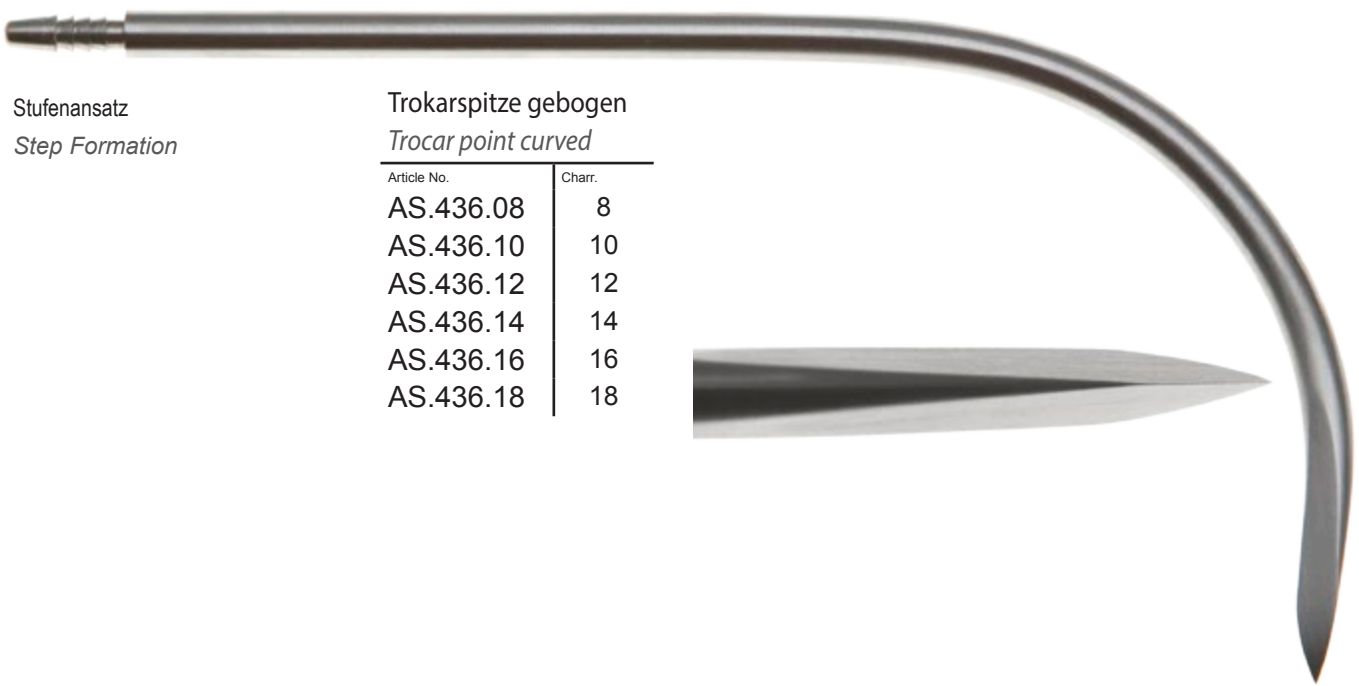

Stufenansatz  
*Step Formation*

Trokarspitze gebogen  
*Trocar point curved*

Article No.	Charr.
AS.436.08	8
AS.436.10	10
AS.436.12	12
AS.436.14	14
AS.436.16	16
AS.436.18	18

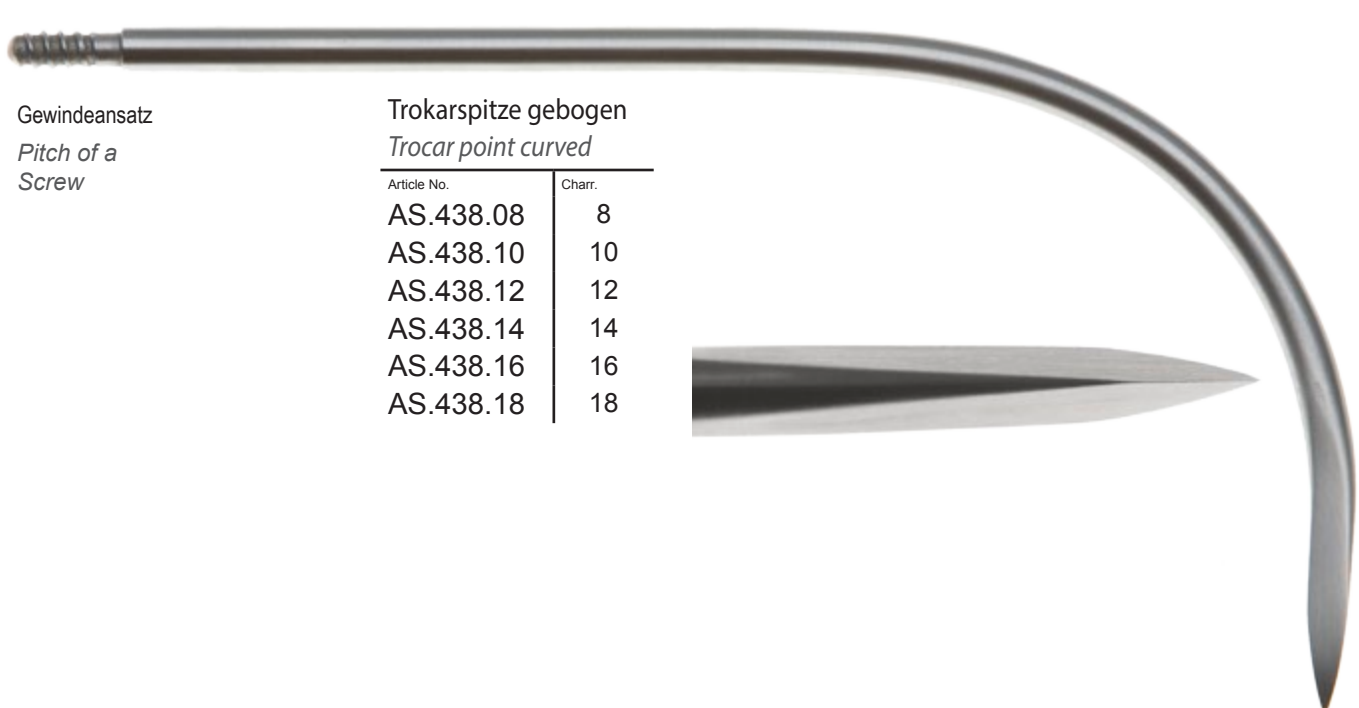

Gewindeansatz  
*Pitch of a Screw*

Trokarspitze gebogen  
*Trocar point curved*

Article No.	Charr.
AS.438.08	8
AS.438.10	10
AS.438.12	12
AS.438.14	14
AS.438.16	16
AS.438.18	18





Sterilisierpinzette

Article No.	Size
AT.075.14	14,0cm



Cheatle Sterilisierzange

Article No.	Size
AT.080.27	27,0cm



MEDE Sterilisierzange

Article No.	Size
AT.084.28	28,0cm

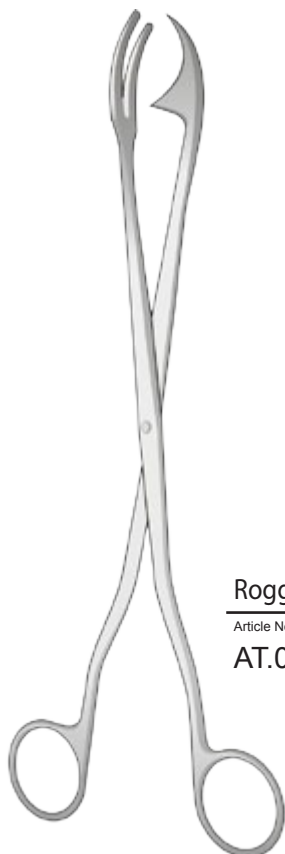

Rogge Sterilisierzange

Article No.	Size
AT.086.23	23,0cm



MEDE Sterilisierzange

Article No.	Size
AT.085.20	20,0cm

**STERILISATION & AUFBEWAHRUNG**  
**STERILIZATION AND CONSERVATION**

ESTERILIZACIÓN Y CONSERVACIÓN  
 STERILISATION ET CONSERVATION  
 SCODELLE ROTONDE, RECIPIENTI CILINDRICI

AT



**Sterilisierzange mit Gabel**

Article No.	Size
AT.087.20	20,0cm
AT.087.30	30,0cm

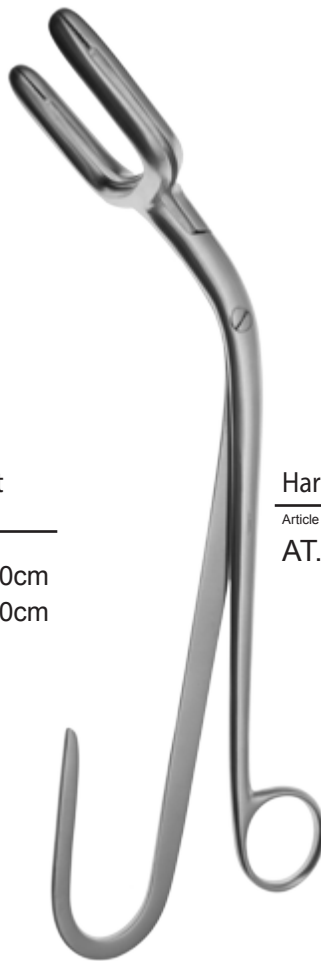

**Harrison Sterilisierzange**

Article No.	Size
AT.088.25	25,0cm

Maulteil stark  
 gezahnt  
 70mm breit



**Saubruch Abfallzange**

Article No.	Size
AP.900.55	55,0cm



**Sterilisierklammer**

Article No.	Size
AT.096.12	12,0cm



**Mayo Sterilisierklammer**

Article No.	Size
AT.096.14	14,0cm



**Mayo Sterilisierklammer**

Article No.	Size
AT.097.18	18,0cm

Entenschnabel  
*duck bill*

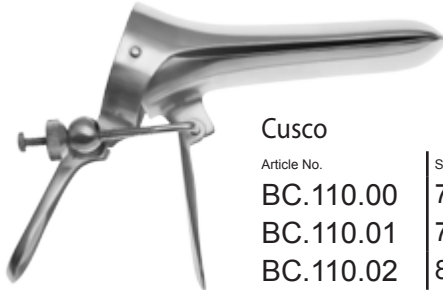

Cusco	
Article No.	Size
BC.110.00	75x15mm
BC.110.01	75x32mm
BC.110.02	85x35mm
BC.110.03	100x35mm

Schweizer Modell  
*Swiss pattern*

Modelo suizo  
 Modèle suisse  
 Especolli vaginali



Cusco	
Article No.	Size
BC.112.01	80x22mm
BC.112.02	100x25mm
BC.112.03	105x27mm

Mittelantrieb  
*Central Screw*

Vis centrale  
 Tornillo central  
 Vite centrale



Cusco	
Article No.	Size
BC.114.00	75x15mm
BC.114.01	80x24mm
BC.114.02	85x36mm
BC.114.03	95x37mm



Collin Spekulum für Kinder

Article No.	Size
BC.122.01	55x10mm



Collin Spekulum für Kinder

Article No.	Size
BC.122.02	95/85x18mm



Collin

Article No.	Size
BC.124.01	85x30mm
BC.124.02	100x35mm
BC.124.03	110x40mm

BC



**Pederson**

Article No.	Size
BC.132.01	75x13mm
BC.132.02	100x22mm
BC.132.03	120x25mm



**Grave**

Article No.	Size
BC.134.01	75x20mm
BC.134.02	95x35mm
BC.134.03	115x35mm



**Sem Spekula**

Article No.	Size
BC.138.01	90x14-16mm
BC.138.02	100x17-20mm Fig1
BC.138.03	100x25-30mm Fig2

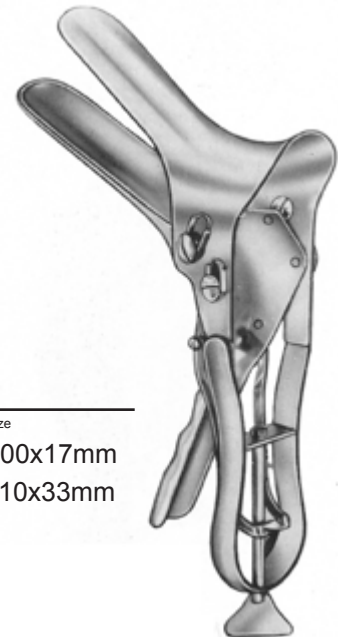

**Seyffert Spekula**

Article No.	Size
BC.140.01	100x17mm
BC.140.02	110x33mm



**Sims doppelendig**

Article No.	Size
BC.150.01	Fig 1 klein
BC.150.02	Fig. 2 mittel
BC.150.03	Fig. 3 groß
BC.150.00	3er Satz

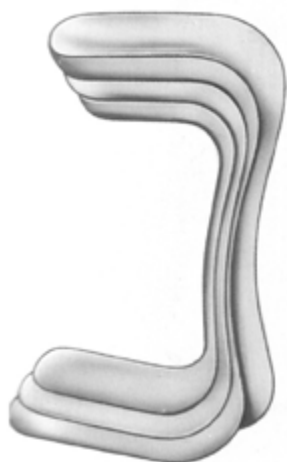

**Seidl Spekula Satz**

Article No.	Size
BC.162.08	80x8mm
BC.162.10	80x10mm
BC.162.14	90x14mm

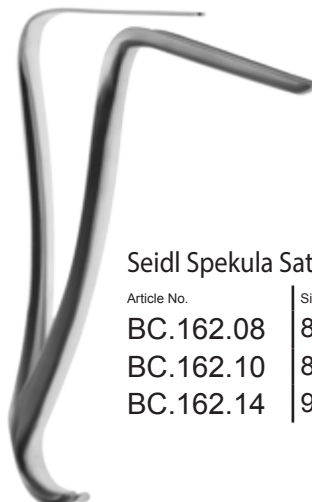

**Kristeller Spekula Sat**

Article No.	Size
BC.176.01	70x27mm Fig1

**Kristeller Satz**

Article No.	Size
BC.180.00	110x18mm
BC.180.01	105x21mm/110x17mm Fig0
BC.180.10	110x27mm Fig1
BC.180.20	110x30mm Fig2
BC.180.22	110x30mm Fig2 nur Spekula
BC.180.30	110x36mm Fig3
BC.180.83	120x30mm nur Halter
BC.182.01	70x27mm kurz
BC.182.02	75x30mm Fig2
BC.182.03	90x36mm Fig3

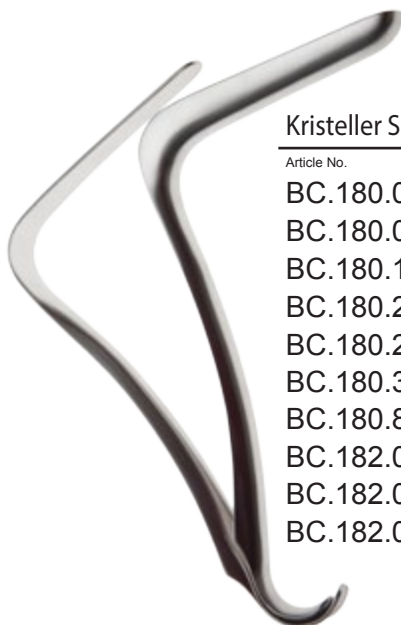

**Kristeller Spekula extra groß**

Article No.	Size
BC.204.00	135x36mm

**Doyen Spekula leicht hohl**

Article No.	Size
BC.240.01	55x35mm Fig 1
BC.240.02	85x35mm Fig 2
BC.240.03	115x35mm Fig 3
BC.240.40	120x40mm Fig. 3 schwarz
BC.241.01	55x45 Fig 1
BC.241.02	85x45 Fig 2
BC.241.03	115x45mm Fig 3
BC.241.04	160x45mm Fig 4
BC.241.40	120x40mm Fig 3 flach
BC.242.02	85x60mm Fig 2
BC.242.03	115x60mm Fig 3
BC.242.04	160x60mm Fig 4

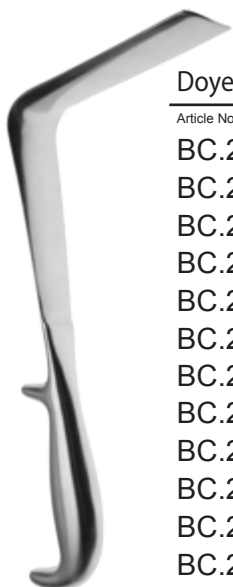

# SCHEIDENSPEKULAS VAGINAL SPECULA

ESPÉCULOS VAGINALES  
SPÉCULUM ET VALVES VAGINAUX  
SPECOLI E VALVE VAGINALI

BC



Doyen Scheidenspekula

Article No.	Size
BC.248.01	60x45mm
BC.248.02	90x45mm
BC.248.03	110x45mm



Breisky 29,0cm

Article No.	Size
BC.270.20	100x20mm
BC.270.25	100x25mm
BC.270.30	100x30mm
BC.270.35	100x35mm
BC.270.40	100x40mm

Breisky 32,0cm

Article No.	Size
BC.271.20	130x20mm
BC.271.25	130x25mm
BC.271.30	130x30mm
BC.271.35	130x35mm
BC.271.40	130x40mm

Breisky 34,5cm

Article No.	Size
BC.272.20	155x20mm
BC.272.25	155x25mm
BC.272.30	155x30mm
BC.272.35	155x35mm
BC.272.40	155x40mm

Breisky 37,0cm

Article No.	Size
BC.273.20	180x20mm
BC.273.25	180x25mm
BC.273.30	180x30mm
BC.273.35	180x35mm
BC.273.40	180x40mm



Kristeller Wiener Satz

Article No.	Size
BC.290.20	110x20mm
BC.290.30	110x30mm
BC.290.36	110x36mm



spitz  
zulaufend

Hegar Uterus Dilator  
einfach

Article No.	Size
BC.310.01	1,0mm
BC.310.02	2,0mm
BC.310.03	3,0mm
BC.310.04	4,0mm
BC.310.05	5,0mm
BC.310.06	6,0mm
BC.310.07	7,0mm
BC.310.08	8,0mm
BC.310.09	9,0mm
BC.310.10	10,0mm
BC.310.11	11,0mm
BC.310.12	12,0mm
BC.310.13	13,0mm
BC.310.14	14,0mm
BC.310.15	15,0mm
BC.310.16	16,0mm
BC.310.17	17,0mm
BC.310.18	18,0mm
BC.310.19	19,0mm
BC.310.20	20,0mm
BC.310.21	21,0mm
BC.310.22	22,0mm
BC.310.23	23,0mm
BC.310.24	24,0mm
BC.310.25	25,0mm
BC.310.26	26,0mm

Hegar Uterus Dilator  
einfach

Article No.	Size
BC.311.01	1,5mm
BC.311.02	2,5mm
BC.311.03	3,5mm
BC.311.04	4,5mm
BC.311.05	5,5mm
BC.311.06	6,5mm
BC.311.07	7,5mm
BC.311.08	8,5mm
BC.311.09	9,5mm
BC.311.10	10,5mm
BC.311.11	11,5mm
BC.311.12	12,5mm
BC.311.13	13,5mm
BC.311.14	14,5mm
BC.311.15	15,5mm
BC.311.16	16,5mm
BC.311.17	17,5mm
BC.311.18	18,5mm
BC.311.19	19,5mm
BC.311.20	20,5mm
BC.311.21	21,5mm
BC.311.22	22,5mm
BC.311.23	23,5mm
BC.311.24	24,5mm
BC.311.25	25,5mm
BC.311.26	26,5mm



Satz mit 14 Dilatatoren

Article No.	Size
BC.310.80	4-17mm

Satz mit 26 Dilatatoren

Article No.	Size
BC.310.90	1-26mm

Hegar Uterus Dilator  
doppelt

Article No.	Size
BC.315.02	1 + 2mm
BC.315.04	3 + 4mm
BC.315.06	5 + 6mm
BC.315.08	7 + 8mm
BC.315.10	9 + 10mm
BC.315.12	11 + 12mm
BC.315.14	13 + 14mm
BC.315.16	15 + 16mm
BC.315.18	17 + 18mm
BC.315.20	19 + 20mm
BC.315.22	21 + 22mm
BC.315.24	23 + 24mm
BC.315.26	25 + 26mm



**PROBEEZSIONSZANGEN**  
**CERVICAL BIOPSY AND SPECIMEN FORCEPS**

PINZAS SACA-BOCADOS PARA BIOPSIA  
 PINCES EMPORTE-PIÈCES À BIOPSIE  
 PINZE TAGLIENTI PER BIOPSIA

BC



Faure  
 21cm  
 BC.503.21



Schubert  
 21cm  
 BC.506.21

29cm  
 BC.506.29

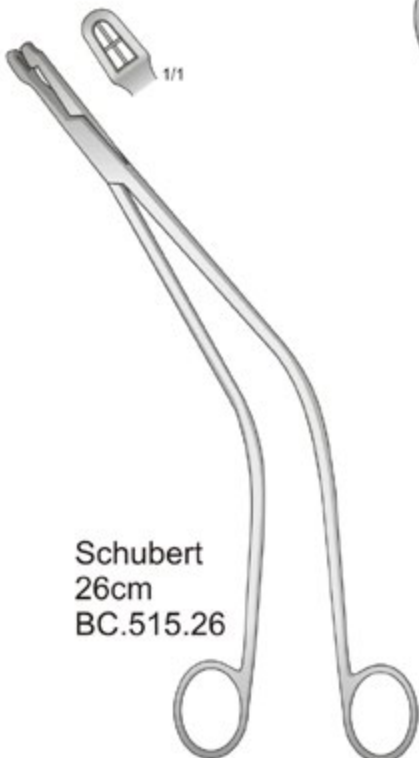

Schubert  
 26cm  
 BC.515.26



Van Doren  
 24cm  
 BC.521.25

# PROBEEZSIZIONSZANGEN CERVICAL BIOPSY AND SPECIMEN FORCEPS

BC

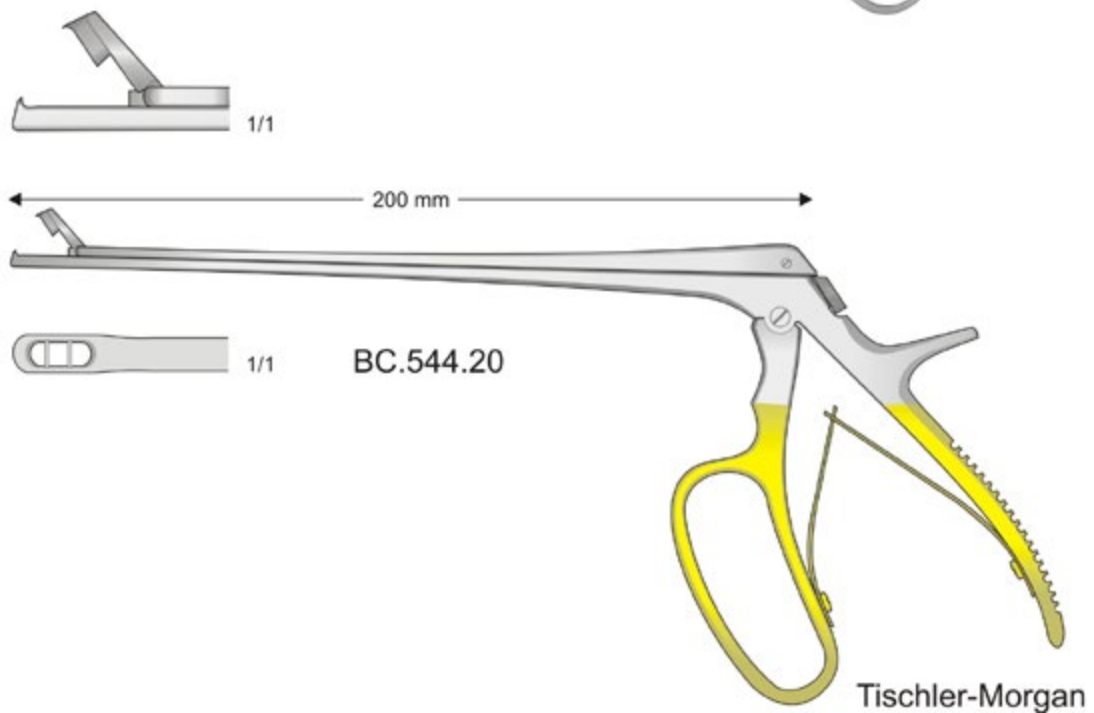

**UTERUS LÖFFEL**  
**UTERINE SCOOPS**

CURETAS UTERINAS  
CURETTES UTÉRINES  
CURETTE UTERINE

BC



Simon  
24cm



Fig.1  
BC.830.01



Fig.2  
BC.830.02



Fig.3  
BC.830.03



Fig.4  
BC.830.04



Fig.5  
BC.830.05



Fig.6  
BC.830.06



Schröder  
31cm



Fig.1  
BC.832.01



Fig.2  
BC.832.02



Fig.3  
BC.832.03



Fig.4  
BC.832.04



Fig.5  
BC.832.05



Fig.6  
BC.832.06



De Bakey - Brainbridge  
15,5cm



De Bakey - Brainbridge  
18cm



Derra 17cm

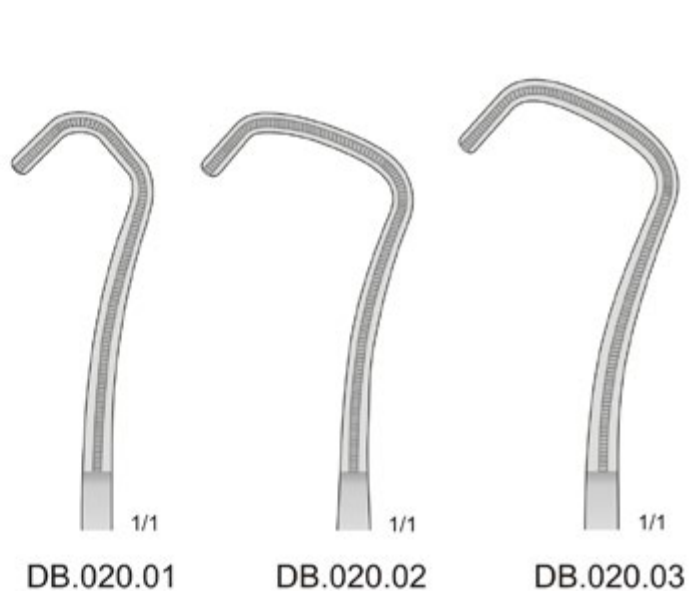



**ATRAUMATISCHE GEFÄSSKLEMMEN**  
**ATRAUMATIC VASCULAR CLAMP**

PINZAS VASCULARES CON BOCAS ATRAUMATIC  
PINCE-CLAMPS VASCULAIRES ATRAUMATIQUES  
PINZE VASCOLARI ATRAUMATIC

DB



Leland-Jones



18,5cm  
DB.025.18



19cm  
DB.027.19



De Bakey 18cm  
DB.031.18





# ATRAUMATISCHE GEFÄSSKLEMMEN ATRAUMATIC VASCULAR CLAMP

DB



De Bakey 20cm  
DB.035.20



De Bakey 22cm  
DB.038.22

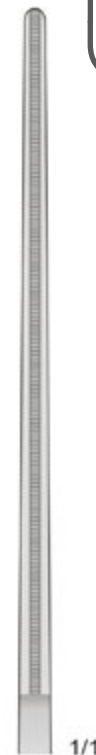

Cooley

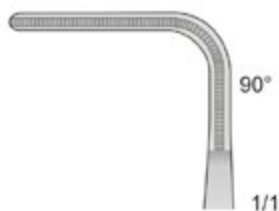

14cm  
DB.041.14

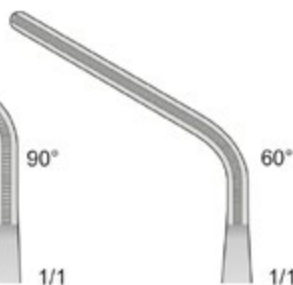

15cm  
DB.041.15



16cm  
DB.041.16

**ATRAUMATISCHE GEFÄSSKLEMMEN**  
**ATRAUMATIC VASCULAR CLAMP**

PINZAS VASCULARES CON BOCAS ATRAUMATIC  
PINCE-CLAMPS VASCULAIRES ATRAUMATIQUES  
PINZE VASCOLARI ATRAUMATIC

DB

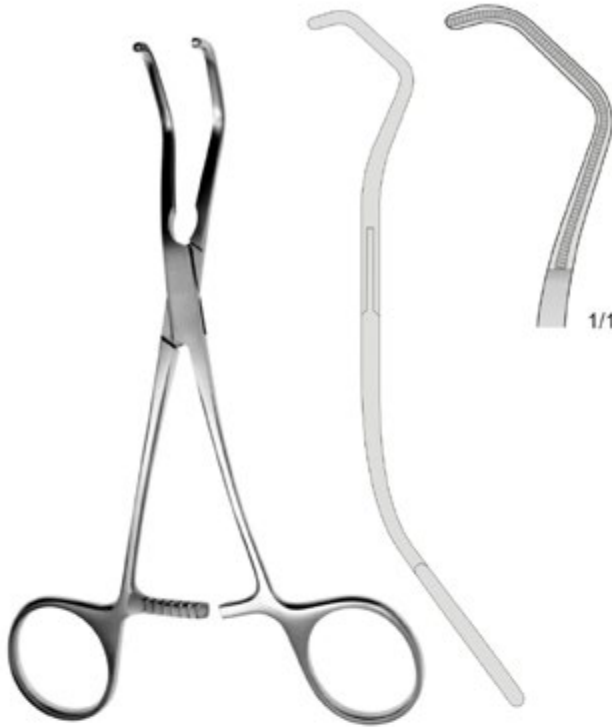

Cooley 16cm  
DB.045.16

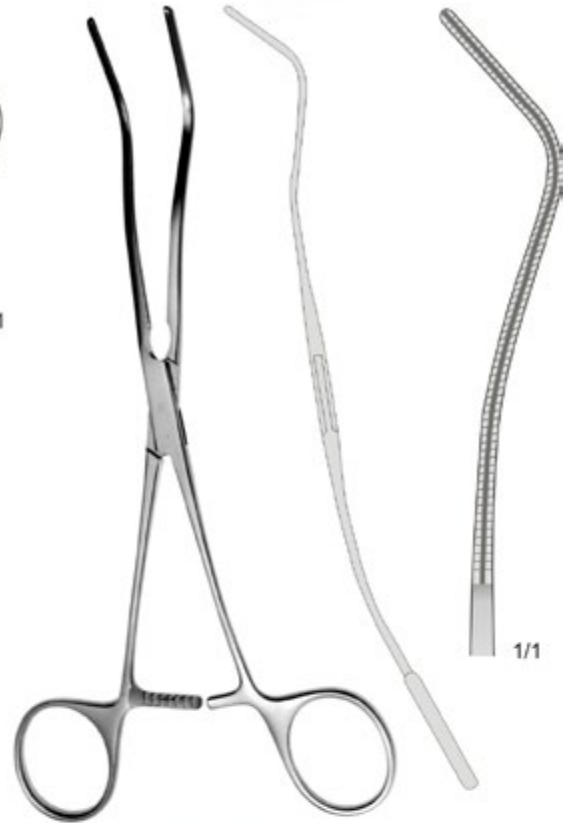

Cooley 20cm  
DB.047.20



De Bakey 15cm



DB.051.15



DB.053.15

PINZAS VASCULARES CON BOCAS ATRAUMATIC  
PINCE-CLAMPS VASCULAIRES ATRAUMATIQUES  
PINZE VASCOLARI ATRAUMATIC

## ATRAUMATISCHE GEFÄSSKLEMMEN ATRAUMATIC VASCULAR CLAMP

DB

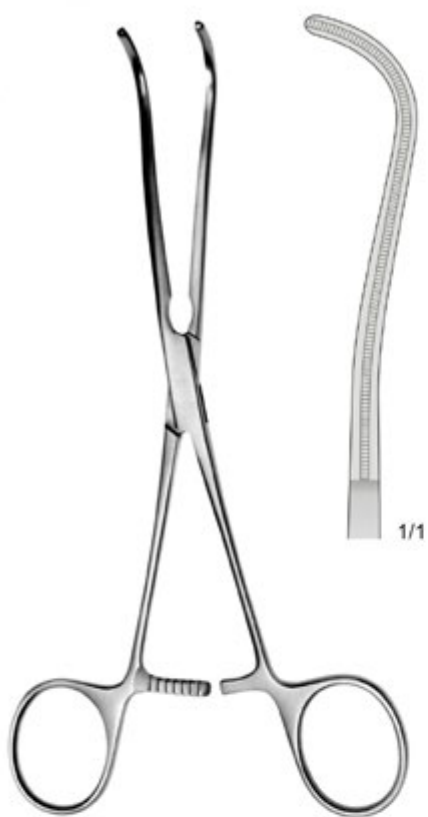

De Bakey 19cm  
DB.057.19

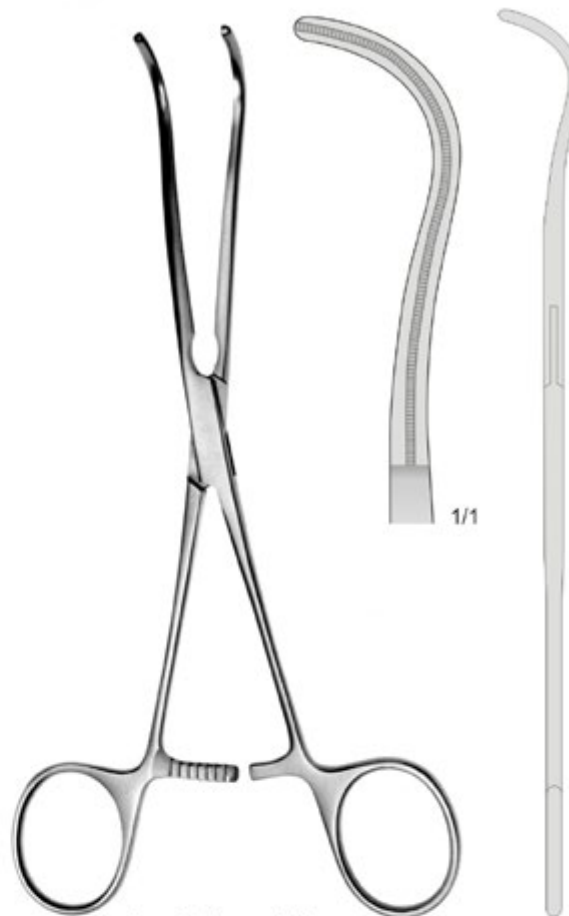

De Bakey 23cm  
DB.057.23



De Bakey 16,5cm  
DB.059.16

**ATRAUMATISCHE GEFÄSSKLEMMEN**  
**ATRAUMATIC VASCULAR CLAMP**

PINZAS VASCULARES CON BOCAS ATRAUMATIC  
PINCE-CLAMPS VASCULAIRES ATRAUMATIQUES  
PINZE VASCOLARI ATRAUMATIC

DB

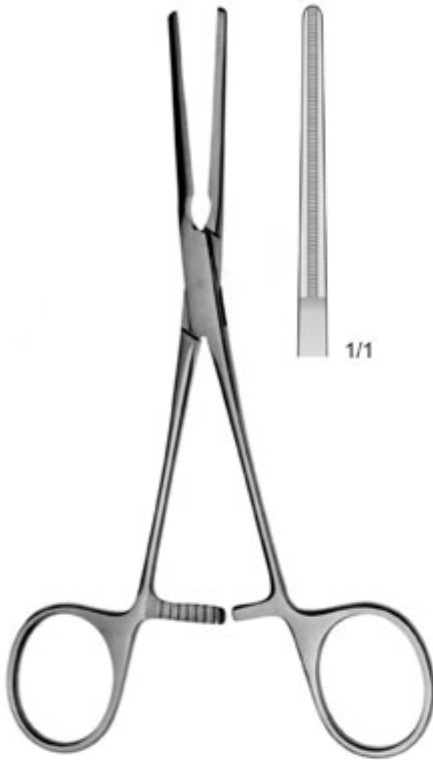

De Bakey 16,5cm  
DB.062.16



De Bakey 16,5cm  
DB.063.16

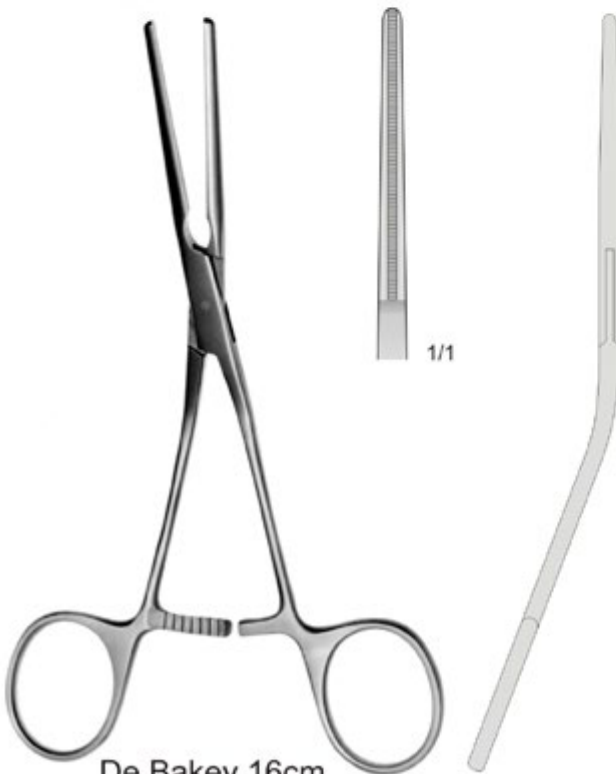

De Bakey 16cm  
DB.064.16

PINZAS VASCULARES CON BOCAS ATRAUMATIC  
PINCE-CLAMPS VASCULAIRES ATRAUMATIQUES  
PINZE VASCOLARI ATRAUMATIC

## ATRAUMATISCHE GEFÄSSKLEMMEN ATRAUMATIC VASCULAR CLAMP

DB

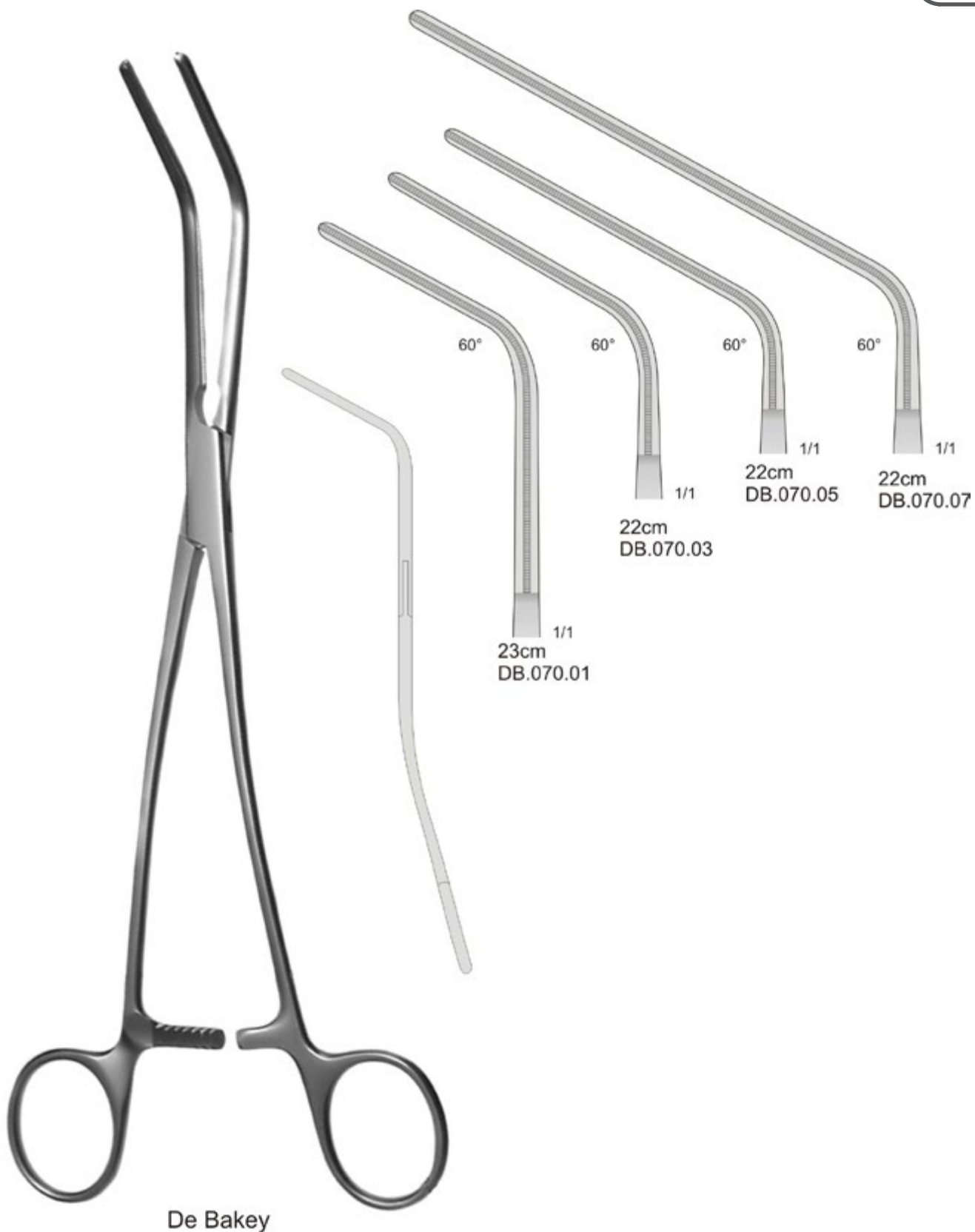

**ATRAUMATISCHE GEFÄSSKLEMMEN**  
**ATRAUMATIC VASCULAR CLAMP**

PINZAS VASCULARES CON BOCAS ATRAUMATIC  
PINCE-CLAMPS VASCULAIRES ATRAUMATIQUES  
PINZE VASCOLARI ATRAUMATIC

DB



De Bakey



1/1

20cm  
DB.074.20



1/1

23cm  
DB.074.23



1/1

24cm  
DB.074.24



1/1

20cm  
DB.075.20



1/1

23cm  
DB.074.23



1/1

24cm  
DB.074.24

# ATRAUMATISCHE GEFÄSSKLEMMEN ATRAUMATIC VASCULAR CLAMP

DB

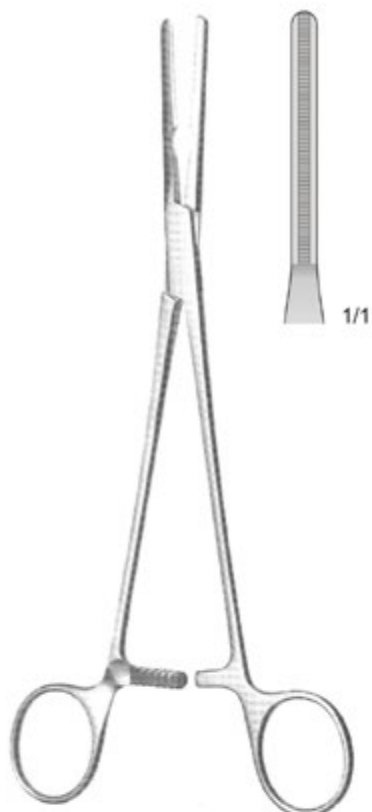

De Bakey 21,5cm  
DB.078.21



De Bakey 21,5cm  
DB.079.21



De Bakey

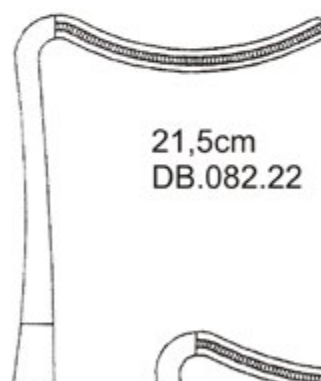
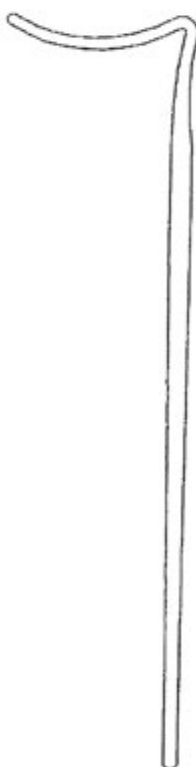

21,5cm  
DB.082.22

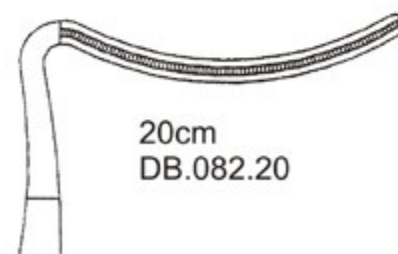

20cm  
DB.082.20

**ATRAUMATISCHE GEFÄSSKLEMMEN**  
**ATRAUMATIC VASCULAR CLAMP**

PINZAS VASCULARES CON BOCAS ATRAUMATIC  
PINCE-CLAMPS VASCULAIRES ATRAUMATIQUES  
PINZE VASCOLARI ATRAUMATIC

DB



De Bakey

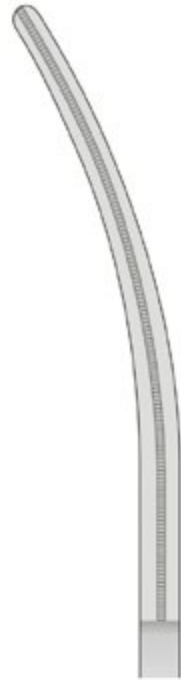

25cm  
DB.087.25



27cm  
DB.087.27

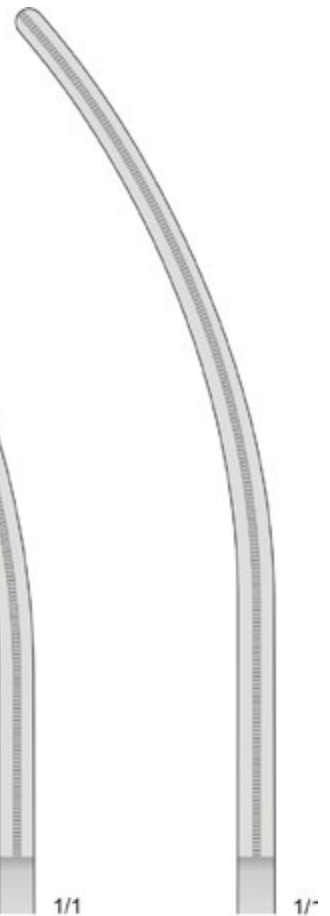

28cm  
DB.087.28



Lambert-Kay 22cm  
DB.091.22





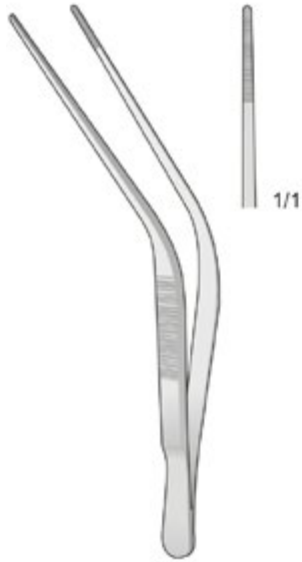

Troeltsch (Wilde) 13cm  
FA.301.13

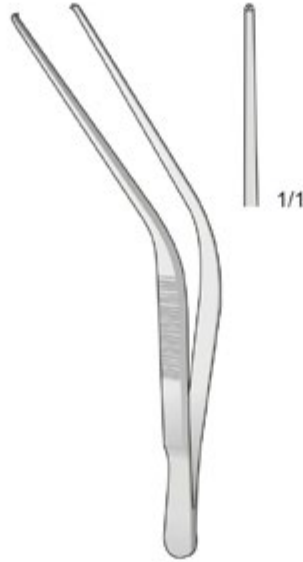

FA.302.13

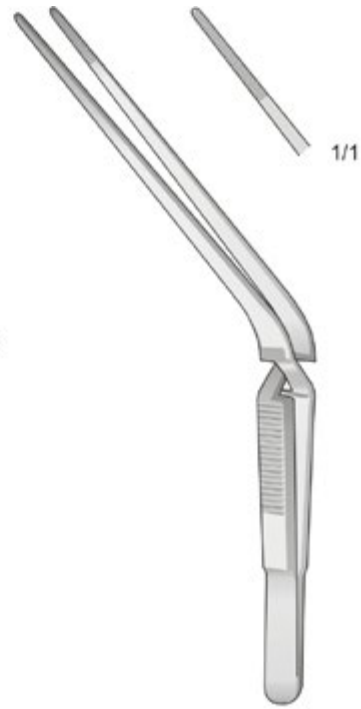

Troeltsch (Wilde) 13cm  
FA.305.13



Lucae 14cm  
FA.309.14



Jansen 16cm  
FA.309.16



Jansen 16cm  
FA.310.16







Jansen 19cm  
FA.309.19

**KNOCHENSTANZEN**  
**BONE CUTTING FORCEPS**

PINZA CORTANTES PARA HUESOS  
OSTÉOTOMES EMPORTE-PIÈCES  
PINZE OSTEOTOMI

FA

-  FA.600.20 = 2mm
-  FA.600.25 = 2,5mm
-  FA.600.30 = 3mm
-  FA.600.35 = 3,5mm
-  FA.600.40 = 4mm

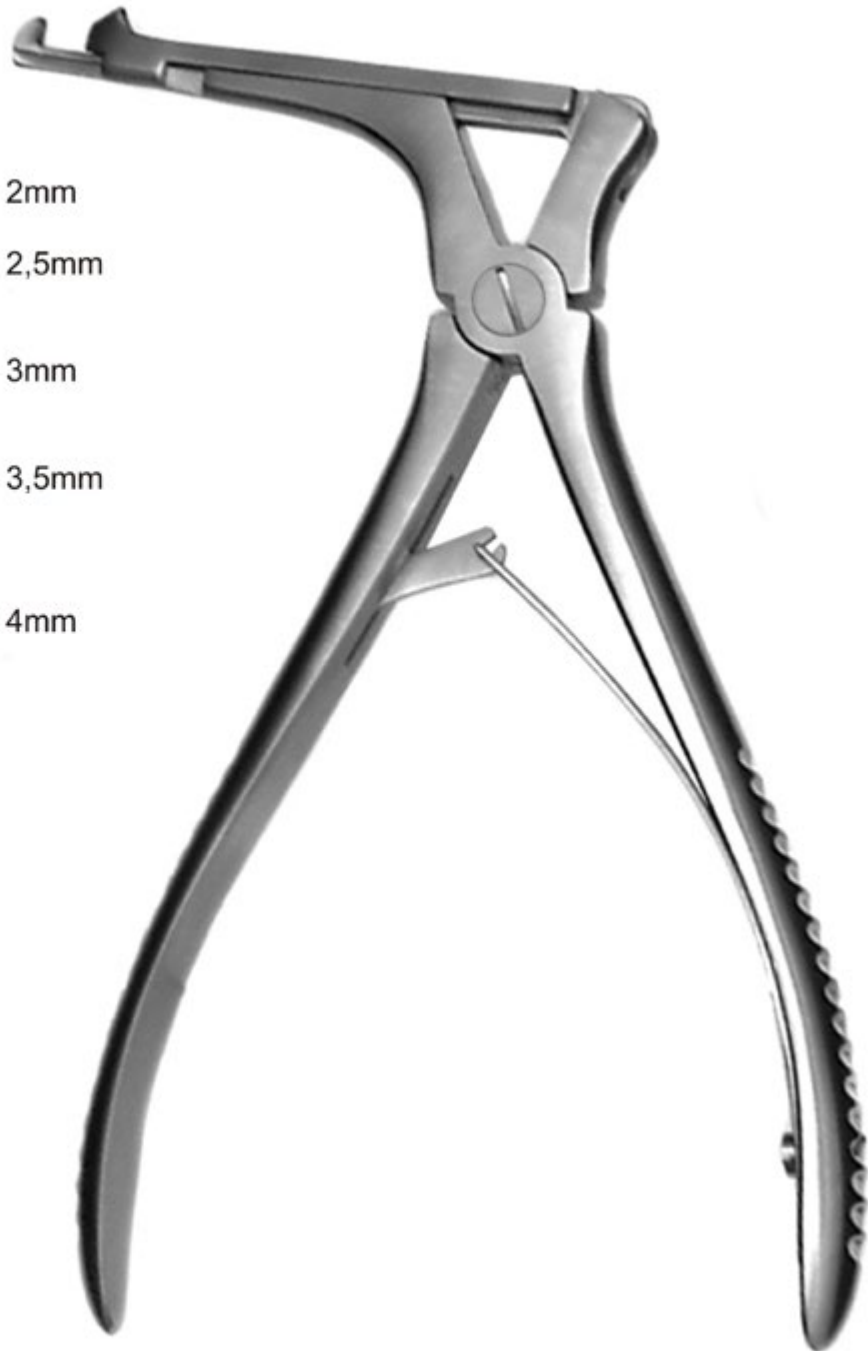

Citelli

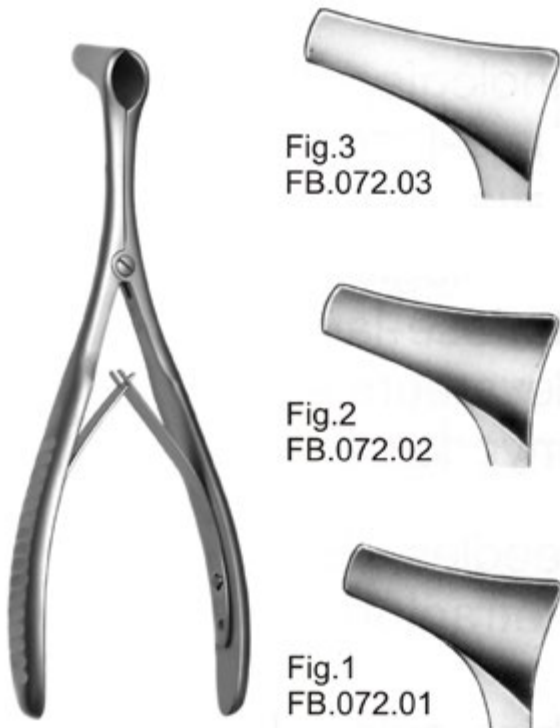

**Hartmann**

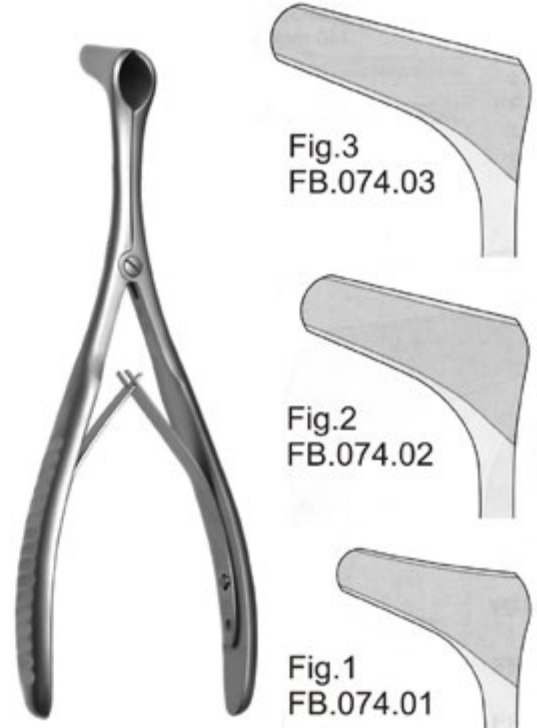

**Hartmann-Halle**

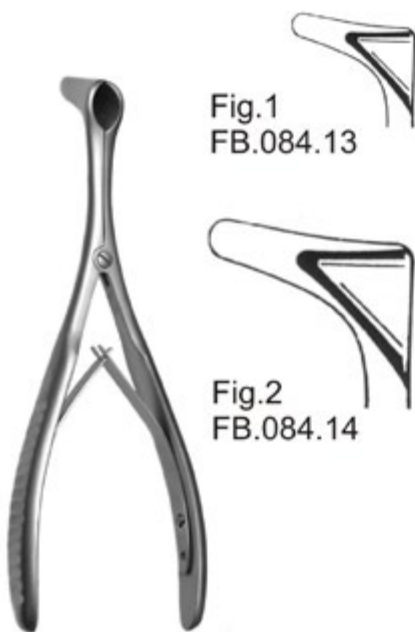

**Tieck-Halle**

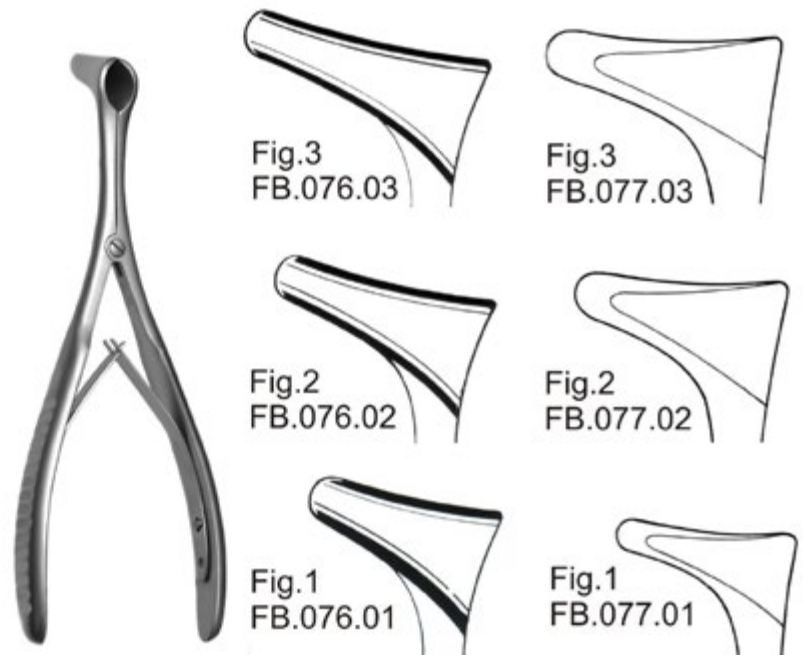

**Wiener Modell**

**NASENSPEKULAS**  
**NASAL SPECULA**

FB

SPÉCULUMS NAsAUX  
ESPÉCULOS NAsALES  
SPECOLI NASALI

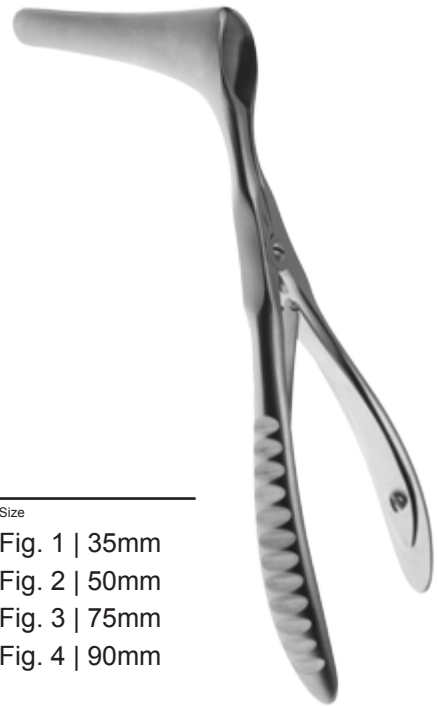
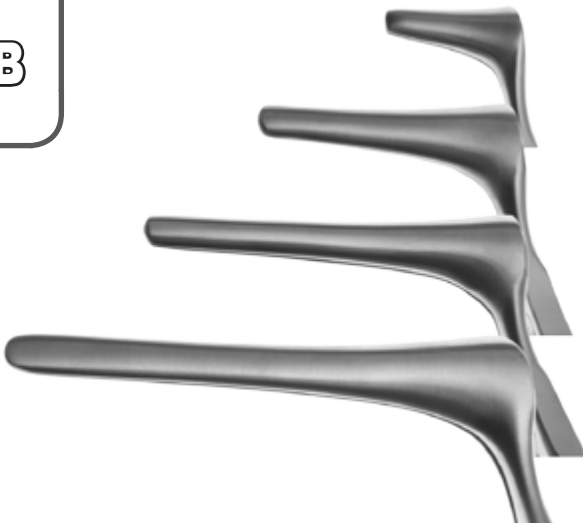

**Killian**

Article No.	Size
FB.090.35	Fig. 1   35mm
FB.090.50	Fig. 2   50mm
FB.090.75	Fig. 3   75mm
FB.090.90	Fig. 4   90mm

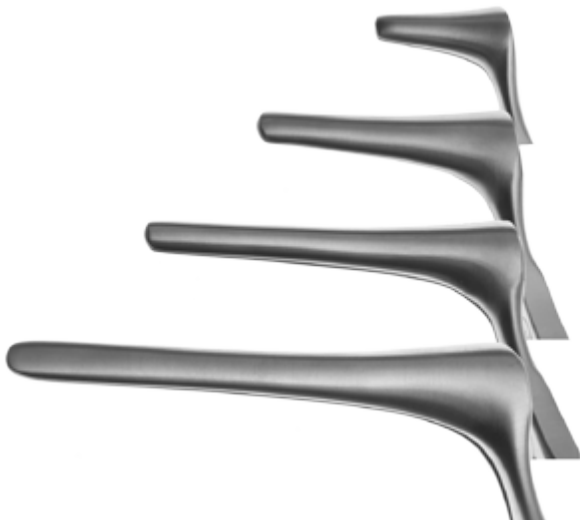

**Cottle - mit Stellschraube**

Article No.	Size
FB.100.35	Fig. 1   35mm
FB.100.50	Fig. 2   50mm
FB.100.75	Fig. 3   75mm
FB.100.90	Fig. 4   90mm



Walter - dünnes Blatt  
Mit Stellschraube

Article No.	Size
FB.101.35	Fig. 1   35mm
FB.101.55	Fig. 2   55mm
FB.101.75	Fig. 3   75mm
FB.101.90	Fig. 4   90mm



Walter - schwarz verchromt  
dünnes Blatt - mit Stellschraube

Article No.	Size
FB.102.35	Fig. 1   35mm
FB.102.50	Fig. 2   50mm
FB.102.75	Fig. 3   75mm
FB.102.90	Fig. 4   90mm

**FOMON RASPELN**  
**FOMON RASPS**

FOMON RASPA  
 FOMON TÂPES  
 FOMON LIMA PER OS

FB



TC



1



3



5



7



9



2



4



6



8



10

Fomon HM Raspel

Size  
 20,0cm

FB.800.12

FB.800.34

FB.800.56

FB.800.78

FB.800.90

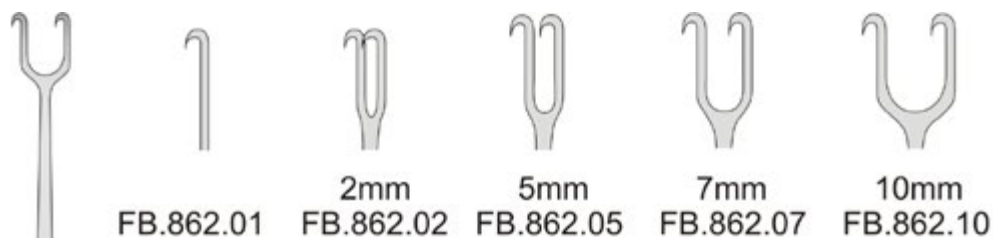

Joseph 16cm

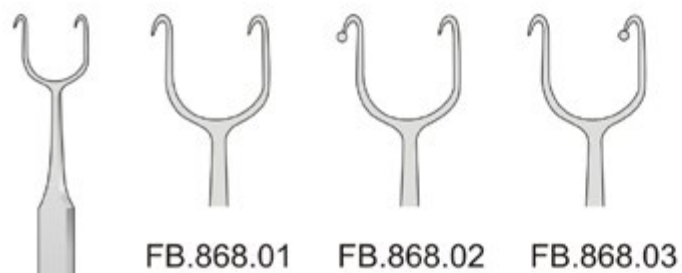

Cottle 15cm



Fomon 16cm  
FB.864.16



**RASPATORIEN**  
**RASPATORIES**

PERIOSTÔTOMES  
RUGINES  
PERIOSTOMI

KA

Handgriff aus  
Ferozell oder Thermoplast (blau)



KA.137.18

KA.138.06

KA.138.04

KA.138.03

Raspatorium

Article No.	Size
KA.136.18	18,0cm

Raspatorium

Article No.	Size
KA.138.18	18,0cm

Raspatorium

Article No.	Size
KA.140.18	18,0cm



Handgriff aus  
Ferozell oder Thermoplast (blau)

14mm



KA.144.14

Raspatorium

Article No.	Size
KA.141.14	20,0cm



14mm



KA.145.14

Raspatorium

Article No.	Size
KA.142.14	20,0cm



20mm



KA.143.20

Raspatorium

Article No.	Size
KA.142.20	20,0cm



**KNOCHENHEBEL**  
**BONE LEVERS**

ELEVADORES PARA HUESOS  
LEVIERSÀ OS  
ELEVATORIS PER OSSA

KA

1:1

5mm



7mm



6mm



8mm



Knochenebel

Article No.	Size
KA.300.05	14,0cm

Knochenebel

Article No.	Size
KA.300.07	14,0cm

Mini Hohmann

Article No.	Size
KA.302.06	16,0cm

Mini Hohmann

Article No.	Size
KA.302.08	16,0cm

1:1



Knochenheber

Article No.	Size
KA.304.12	12,5cm

Knochenheber

Article No.	Size
KA.304.15	15,0cm

Knochenheber

Article No.	Size
KA.306.15	16,0cm

Knochenheber

Article No.	Size
KA.307.14	14,0cm

**KNOCHENHEBEL**  
**BONE LEVERS**

ELEVADORES PARA HUESOS  
LEVIERSÀ OS  
ELEVATORIS PER OSSA

KA





Hohmann  
KA.320.70  
24,0cm

Hohmann  
KA.321.43  
24,5cm

Hohmann  
KA.323.22  
26,0cm

Hohmann  
KA.323.33  
28,0cm

**KNOCHENHEBEL**  
**BONE LEVERS**

ELEVADORES PARA HUESOS  
LEVIERSÀ OS  
ELEVATORIS PER OSSA

KA

1:2



Hohmann  
KA.324.24  
26,0cm



Lange-Hohmann  
KA.325.22  
26,0cm



Lange-Hohmann  
KA.325.30  
26,5cm



Lange-Hohmann  
KA.325.33  
28,0cm

1:2

KA



Lange-Hohmann

KA.326.14

14,0cm

18x35mm  
Unterseite kariert



Schumacher

KA.326.29

29,0cm

18x37mm



Schumacher

KA.326.34

34,5cm

**KNOCHENHEBEL**  
**BONE LEVERS**

ELEVADORES PARA HUESOS  
LEVIERSÀ OS  
ELEVATORIS PER OSSA

KA

1:2



Verbrügge  
Like Simal

KA.327.25

20,0cm



Verbrügge  
Müller

KA.327.44

24,0cm



Verbrügge  
Müller

KA.327.65

25,5cm



1:2

KA

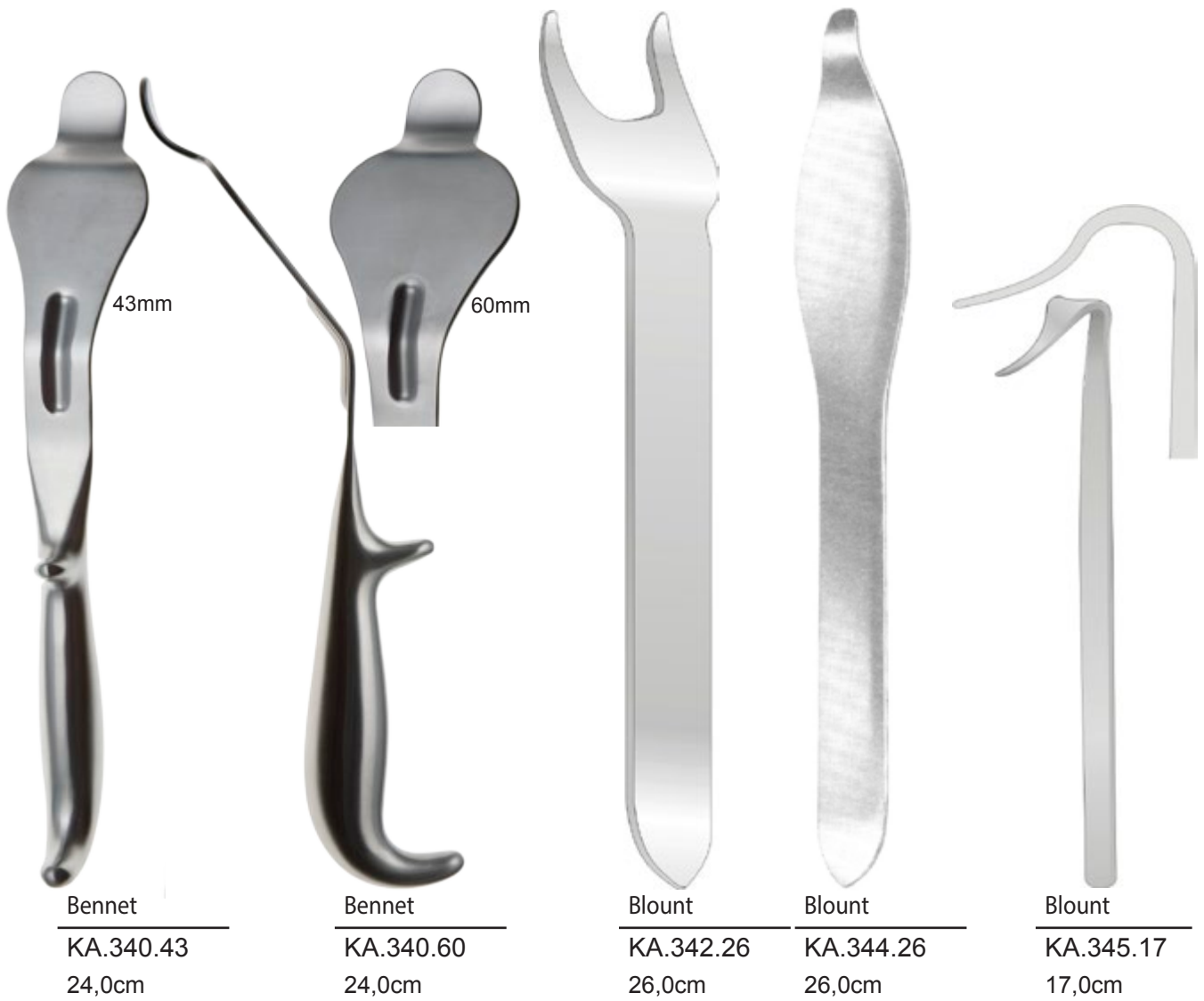

**KNOCHENFEILEN / RASPELN**  
**BONE FILES / RASPS**

LIMAS PARA HUESOS, ESCOFINAS  
LIMES À OS, RASPES À OS  
LIME PER OSSO, RASPE

KA

1:2



Putti  
KA.501.30  
30,0cm



Putti  
KA.502.27  
27,0cm



Knochenfeile  
KA.510.29  
29,5cm



Knochenfeile  
KA.514.24  
24,5cm



Knochenfeile  
KA.516.22  
22,0cm



Ganzmetall 600g

Article No.	Size
KB.204.20	20,0cm



Collin 220g / Ø 30mm

Article No.	Size
KB.208.20	20,0cm



Lucae 260g / Ø 25mm

Article No.	Size
KB.210.02	19,5cm

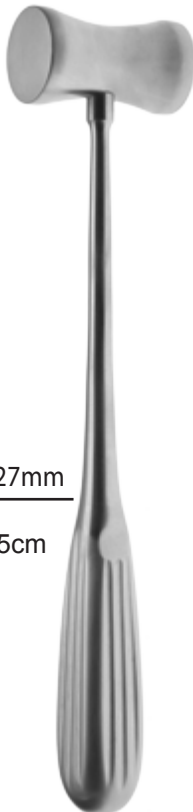

Hajek 140g (Kopf) / Ø 27mm

Article No.	Size
KB.210.19	21,5cm



Doyen / 21,0cm

Article No.	Weight
KB.212.01	120g
KB.212.02	180g
KB.212.03	260g

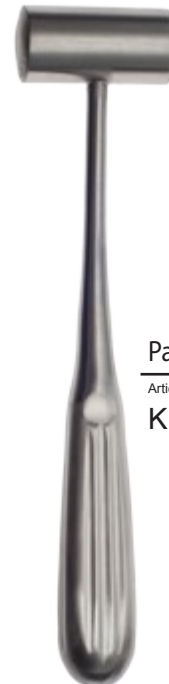
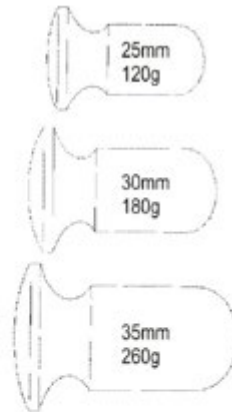

Partsch 220g / Ø 22mm

Article No.	Size
KB.214.19	19,0cm

**HÄMMER  
MALLETs**

MARTILLOS Y MAZOS  
MAILLETS  
MARTELLI

**KB**

Williger / 24,0cm

Article No.	Weight
KB.216.01	300g
KB.216.02	340g
KB.216.03	400g

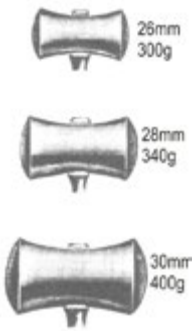

Mit Wechselbern Backen  
370g / Ø 37mm

Article No.	Size
KB.224.22	24cm

Hammer 530g  
Ø 30/40mm

Article No.	Size
KB.220.26	26,0cm

Mit Stahlkopf / Ø 30mm

Article No.	Size
KB.222.24	24,0cm



Ersatzbacken paar  
Ø 37mm

Article No.	Size
KB.224.90	



40mm  
700g

Heath 700g / Ø 40mm

Article No.	Size
KB.230.18	18,5cm



40mm  
550g

550g / Ø 40mm

Article No.	Size
KB.232.18	18,0cm



50mm  
900g

900g / Ø 50mm

Article No.	Size
KB.234.18	18,0cm



40mm  
550g

Omredanne 550g

Article No.	Size
KB.235.24	24,0cm



Omredanne 1600g

Article No.
KB.235.99



Rückschlagfrei

Article No.
KB.238.29

**HÄMMER  
MALLETS**

MARTILLOS Y MAZOS  
MAILLETS  
MARTELLI

**KB**



Ferozell / Stahl  
26,5cm

Article No.	
KB.240.01	450g
KB.240.02	900g



Bergmann / Ø 50mm

Article No.	Size
KB.242.23	23,5cm

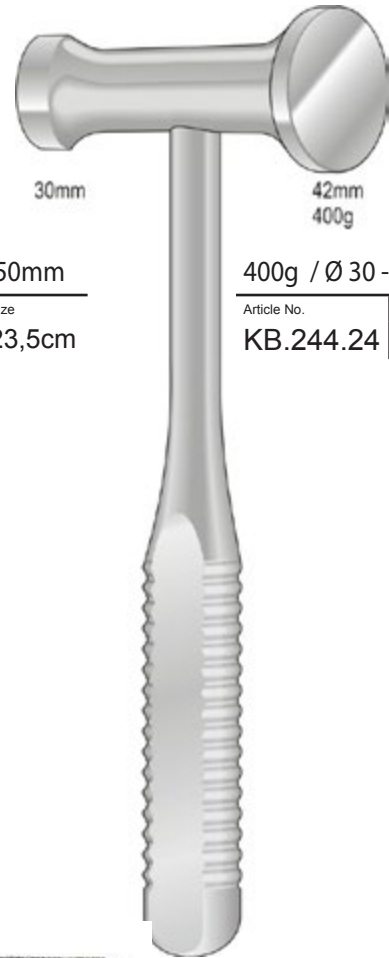

30mm

42mm  
400g

400g / Ø 30 - 42mm

Article No.	Size
KB.244.24	24,0cm



45mm  
300g

Bergmann  
300g / Ø 45mm

Article No.	Size
KB.246.24	24,5cm

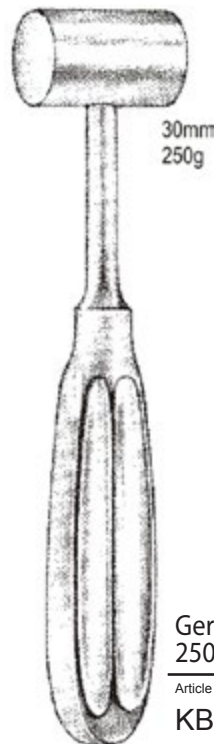

30mm  
250g

Gerzog  
250g / Ø 30mm

Article No.	Size
KB.250.19	19,5cm

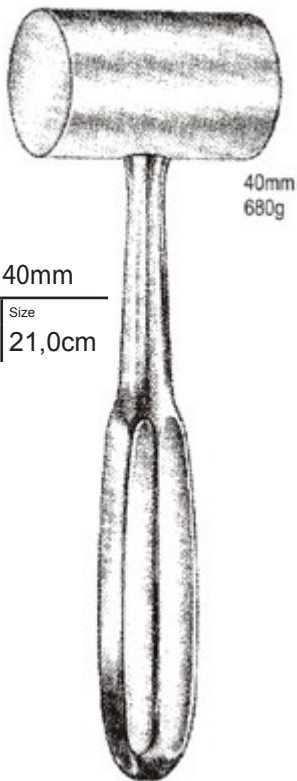

Kirk 680g / Ø 40mm

Article No.	Size
KB.250.21	21,0cm



Spezial Hammer  
24,0cm

Article No.	Weight
KB.254.01	350g
KB.254.02	500g
KB.254.03	700g



20mm  
200g

Ersatzbacken  
1 Paar  
KB.262.90

Bleifüllung Ø 22mm

Article No.	Size
KB.260.16	16,0cm

Kunststoffbacken  
140g / Ø 25mm

Article No.	Size
KB.262.19	19,0cm



1Seite flach  
1Seite konvex  
1side flat  
1side convex

Cottle 240g / Ø30mm

Article No.	Size
KB.264.19	19,0cm



26mm  
320g

Ersatzbacken  
1 Paar  
KB.266.90

Mead 320g / Ø26mm

Article No.	Size
KB.266.18	18,0cm



Ferrozell Hammer



35x55mm  
KB.276.06



45x70mm  
KB.276.16



50x80mm  
KB.276.26



42x70mm  
KB.278.26





350g / Ø 30mm

Article No.	Size
KB.282.24	24,0cm



700g / Ø40mm

Article No.	Size
KB.283.70	24,0cm



Silikon Rundgriff



500g

Article No.	Size
KB.283.50	24,0cm

300g / Ø 27mm

Article No.	Size
KB.283.30	24,0cm

Schlitzhammer rund

Article No.
KB.400.30



Ersatzbacken

Pair of spare disks

Article No.
KB.284.66

250g / Ø 30mm

Article No.	Size
KB.284.48	24,0cm

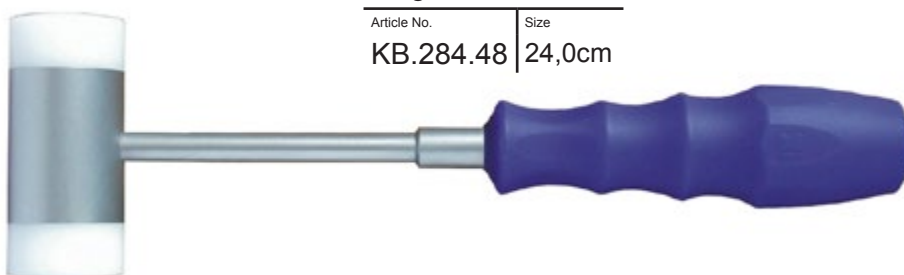

**MEISSEL & OSTEOTOME**  
**CHISELS AND GOUGES**

OSTEÓTOMES, CINSELES, GUBIAS  
 OSTÉOTOMES, CISEAUX-BURINS, GUBIAS  
 OSTEOTOMI, SCALPELLI

KC



**13,5cm**

- KC.050.08 = 8mm
- KC.050.10 = 10mm
- KC.050.12 = 12mm
- KC.050.14 = 14mm
- KC.050.16 = 16mm



**13,5cm**

- KC.051.08 = 8mm
- KC.051.10 = 10mm
- KC.051.12 = 12mm
- KC.051.14 = 14mm
- KC.051.16 = 16mm



**13,5cm**

- KC.052.08 = 8mm
- KC.052.10 = 10mm
- KC.052.12 = 12mm
- KC.052.14 = 14mm
- KC.052.16 = 16mm



**Partsch**



**13,5cm**

- KC.060.02 = 2mm
- KC.060.03 = 3mm
- KC.060.04 = 4mm
- KC.060.05 = 5mm
- KC.060.06 = 6mm



**17cm**

- KC.061.02 = 2mm
- KC.061.03 = 3mm
- KC.061.04 = 4mm
- KC.061.05 = 5mm
- KC.061.06 = 6mm



**13,5cm**

- KC.062.02 = 2mm
- KC.062.03 = 3mm
- KC.062.04 = 4mm
- KC.062.05 = 5mm
- KC.062.06 = 6mm



**17cm**

- KC.063.02 = 2mm
- KC.063.03 = 3mm
- KC.063.04 = 4mm
- KC.063.05 = 5mm
- KC.063.06 = 6mm

Andere Modelle auf Anfrage  
 Other patterns on request  
 Otros modelos sobre demanda  
 Autres modèles sur demande



Mini Lambotte - 12,5cm

Article No.	Size
KC.100.03	3,0mm
KC.100.04	4,0mm
KC.100.05	5,0mm
KC.100.06	6,0mm
KC.100.10	10,0cm
KC.100.12	12,0mm
KC.100.15	15,0mm

size



Lambotte - 24,0cm

Article No.	Size
KC.102.04	4,0mm
KC.102.06	6,0mm
KC.102.08	8,0mm
KC.102.10	10,0mm
KC.102.13	13,0mm
KC.102.15	15,0mm
KC.102.18	18,0cm
KC.102.20	20,0mm
KC.102.25	25,0mm
KC.102.30	30,0mm
KC.102.38	38,0mm
KC.102.44	44,0mm
KC.102.50	50,0mm



Lambotte - 24,0cm

Article No.	Size
KC.103.08	8,0mm
KC.103.10	10,0mm
KC.103.13	13,0mm
KC.103.15	15,0mm
KC.103.18	18,0cm
KC.103.20	20,0mm
KC.103.25	25,0mm
KC.103.30	30,0mm
KC.103.38	38,0mm
KC.103.44	44,0mm
KC.103.50	50,0mm



Mini Lambotte - 17,0cm

Article No.	Size
KC.101.03	3,0mm
KC.101.04	4,0mm
KC.101.05	5,0mm
KC.101.06	6,0mm
KC.101.10	10,0cm
KC.101.12	12,0mm
KC.101.15	15,0mm

**MINI LEXER MEISSEL**  
**CHISELS. GOUGES WITH FERROZELL-HANDLE**

CINCELES, GUBIAS  
 CISEAUX-BURINS ET OSTÉOTOMES  
 SCAPELLI E OSTEOTOMI

KC

Lieferbar auch Sonderabmessungen  
 Also available in special sizes  
 También obtenible en tamanos especiales  
 Aussi livrable en mesures spéciales



Mini-Lexer  
18cm

Mini-Lexer  
18cm

Mini-Lexer  
18cm

- KC.110.04 = 4mm
- KC.110.06 = 6mm
- KC.110.08 = 8mm
- KC.110.10 = 10mm
- KC.110.12 = 12mm
- KC.110.15 = 15mm

- KC.111.04 = 4mm
- KC.111.06 = 6mm
- KC.111.08 = 8mm
- KC.111.10 = 10mm
- KC.111.12 = 12mm
- KC.111.15 = 15mm

- KC.112.04 = 4mm
- KC.112.06 = 6mm
- KC.112.08 = 8mm
- KC.112.10 = 10mm
- KC.112.12 = 12mm
- KC.112.15 = 15mm

Lieferbar auch Sonderabmessungen  
Also available in special sizes  
También obtenible en tamanos especiales  
Aussi livrable en mesures spéciales



Lexer Flachmeissel 22,0cm

Article No.	Size
KC.114.05	5mm
KC.114.07	7mm
KC.114.10	10mm
KC.114.12	12mm
KC.114.15	15mm
KC.114.20	20mm
KC.114.25	25mm
KC.114.30	30mm



Lexer Flachmeissel 22,0cm

Article No.	Size
KC.124.05	5mm
KC.124.07	7mm
KC.124.10	10mm
KC.124.12	12mm
KC.124.15	15mm
KC.124.20	20mm
KC.124.25	25mm
KC.124.30	30mm

# LEXER MEISSEL

## OSTEOTOMES, CHISLES, GOUGES

OSTEÓTOMES, CHINCELES, GUBIAS  
CISEAUX-BURINS ET OSTÉOTOMES  
SCALPELLI E OSTEOTOMI

KC

Lieferbar auch Sonderabmessungen  
Also available in special sizes  
También obtenible en tamanos especiales  
Aussi livrable en mesures spéciales



Lexer Hohlmeissel 22,0cm

Article No.	Size
KC.115.05	5mm
KC.115.07	7mm
KC.115.10	10mm
KC.115.15	15mm
KC.115.20	20mm
KC.115.25	25mm
KC.115.30	30mm

Lexer Hohlmeissel 22,0cm

Article No.	Size
KC.125.05	5mm
KC.125.07	7mm
KC.125.10	10mm
KC.125.15	15mm
KC.125.20	20mm
KC.125.25	25mm
KC.125.30	30mm

Lexer Hohlmeissel 22,0cm

Article No.	Size
KC.135.05	5mm
KC.135.07	7mm
KC.135.10	10mm
KC.135.15	15mm
KC.135.20	20mm
KC.135.25	25mm
KC.135.30	30mm

Lieferbar auch Sonderabmessungen  
 Also available in special sizes  
 También obtenible en tamanos especiales  
 Aussi livrable en mesures spéciales



Lexer Flachmeissel  
 Osteotom - 32,0cm

Article No.	Size
KC.116.04	4mm
KC.116.05	5mm
KC.116.07	7mm
KC.116.10	10mm
KC.116.12	12mm
KC.116.15	15mm
KC.116.20	20mm
KC.116.25	25mm
KC.116.30	30mm

Dahmen Flachmeissel - gewinkelt  
 Osteotom - 32,0cm

Article No.	Size
KC.116.55	5mm
KC.116.57	7mm
KC.116.60	10mm
KC.116.62	12mm
KC.116.65	15mm
KC.116.70	20mm
KC.116.75	25mm
KC.116.80	30mm

Lexer Flachmeissel  
 Osteotom - 32,0cm

Article No.	Size
KC.146.04	4mm
KC.146.05	5mm
KC.146.07	7mm
KC.146.10	10mm
KC.146.12	12mm
KC.146.15	15mm
KC.146.20	20mm
KC.146.25	25mm
KC.146.30	30mm

**SPEZIAL HOHL- & SCHWANENHALSMEISSEL**  
**OSTEOTOMES, CHISLES, GOUGES**

OSTEÓTOMES, CHINCELES, GUBIAS  
 CISEAUX-BURINS ET OSTÉOTOMES  
 SCALPELLI E OSTEOTOMI

KC



Lexer Hohlmeissel 32,0cm

Article No.	Size
KC.117.07	7mm
KC.117.10	10mm
KC.117.15	15mm
KC.117.20	20mm
KC.117.25	25mm
KC.117.30	30mm

Schwanhalsmeissel

Article No.	Size
KC.120.25	30,0cm

Flachmeissel  
 gebogene Schneidplatte

Article No.	Size
KC.251.16	32,0cm

Schmäler Meissel  
 gebogen

Article No.	Size
KC.141.09	27,0cm





18cm  
 KC.125.00

18cm  
 KC.125.01

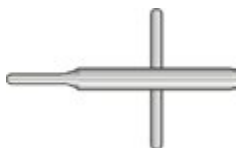

KC.125.90

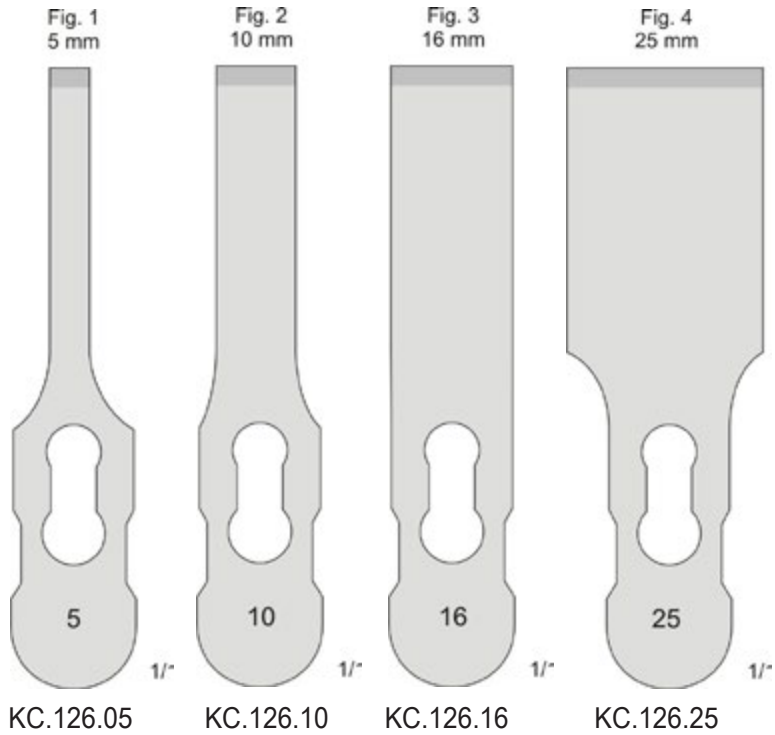

KC.126.05

KC.126.10

KC.126.16

KC.126.25



Osteotom  
 Gouge  
 Gubias  
 Gouges  
 Osteotomi

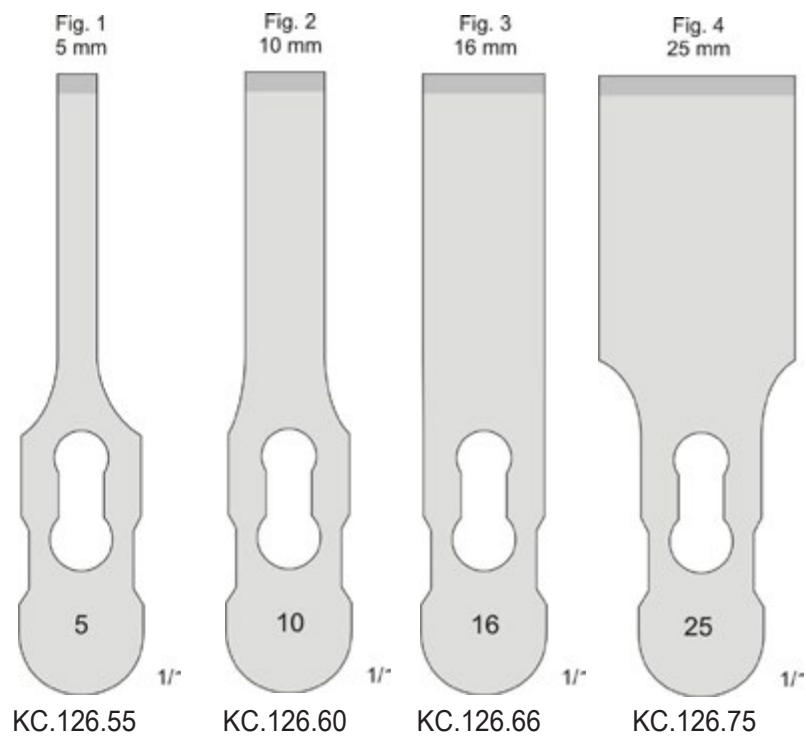

KC.126.55

KC.126.60

KC.126.66

KC.126.75



Meißel  
 Chisel  
 Cinceles  
 Ciseaux-burins  
 Scalpelli

**STILLE MEISSEL & OSTEOTOME**  
**OSTEOTOMES, CHISLES, GOUGES**

OSTEÓTOMES, CHINCELES, GUBIAS  
 CISEAUX-BURINS ET OSTÉOTOMES  
 SCALPELLI E OSTEOTOMI

KC

Meißel/Chisel/Cinseles/Ciseaux-burins/Scalpell



KC.170.10 = 10mm  
 KC.170.15 = 15mm  
 KC.170.20 = 20mm  
 KC.170.25 = 25mm

Stille  
 20cm

Osteotom/Gouge/Gubias/Gougues/Osteotomi

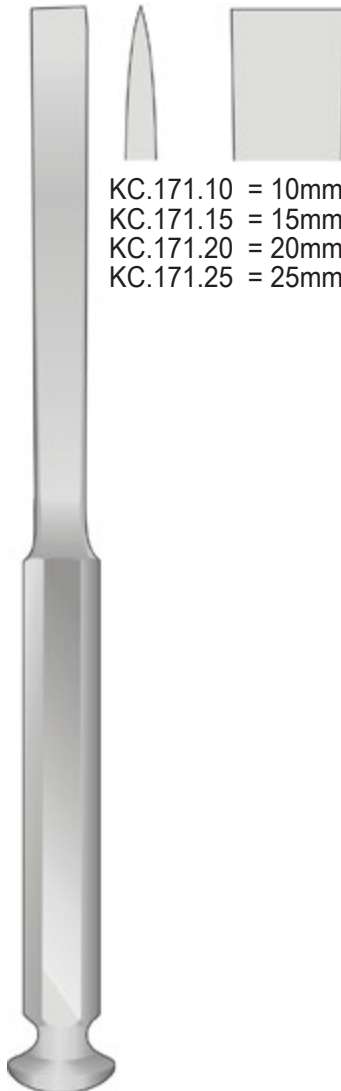

KC.171.10 = 10mm  
 KC.171.15 = 15mm  
 KC.171.20 = 20mm  
 KC.171.25 = 25mm

Stille  
 20cm



KC.172.10 = 10mm  
 KC.172.15 = 15mm  
 KC.172.20 = 20mm  
 KC.172.25 = 25mm

Stille  
 20cm

Meissel zum Freilegen  
abgebrochener Schrauben



Lexer  
22cm



Spongiosa Meissel  
25cm

5mm  
KC.204.05

10mm  
KC.204.10

15mm  
KC.204.15



Spongiosa Meisse  
25cm

5mm  
KC.205.05

10mm  
KC.205.10

15mm  
KC.205.15

**HOHLMEISSEL**  
**OSTEOTOMES, CHISLES, GOUGES**

OSTEÓTOMES, CHINCELES, GUBIAS  
CISEAUX-BURINS ET OSTÉOTOMES  
SCALPELLI E OSTEOTOMI

KC



Zielke  
23cm  
KC.208.55 = 5,5mm  
KC.208.90 = 9,0mm

COBB  
28cm  
KC.210.01

COBB  
28cm  
KC.210.02

COBB  
28cm  
KC.210.03

COBB  
28cm  
KC.210.04

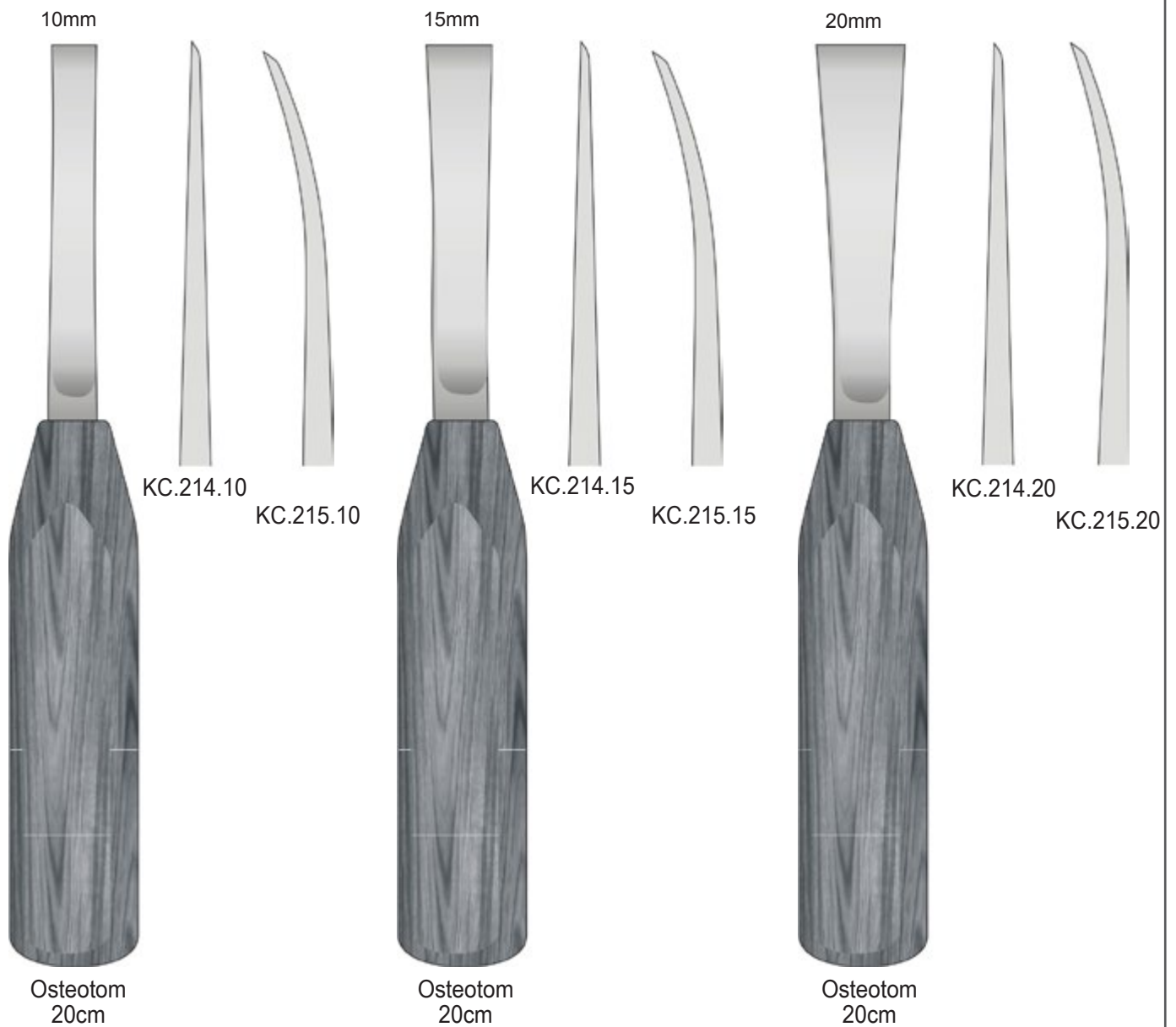

**MEISSEL & OSTEOTOME**  
**CHISELS AND GOUGES**

OSTEÓTOMES, CINSELES, GUBIAS  
 OSTÉOTOMES, CISEAUX-BURINS, GUBIAS  
 OSTEOTOMI, SCALPELLI

KC



Smith-Petersen  
20cm



Smith-Petersen  
20cm



Smith-Petersen  
20cm



Smith-Petersen  
20cm

6mm	KC.220.06
9mm	KC.220.09
13mm	KC.220.13
14mm	
16mm	KC.220.16
19mm	KC.220.19
25mm	KC.220.25
32mm	KC.220.32

KC.222.06
KC.222.09
KC.222.13
KC.222.16
KC.222.19
KC.222.25
KC.222.32

KC.223.09
KC.223.14
KC.223.19
KC.223.25
KC.223.32

KC.225.09
KC.225.14
KC.225.19
KC.225.25
KC.225.32



Silver Meissel  
gerade  
18cm  
KC.870.01



Silver Meissel  
links gebogen  
18cm  
KC.870.02



Silver Meissel  
rechts gebogen  
18cm  
KC.870.03

**SCHARFE LÖFFEL**  
**BONE CURETTES**

CUCHARILLAS CORTANTES  
CURETTES  
CURETTE TAGLIANTI

KD



Syvert  
38cm

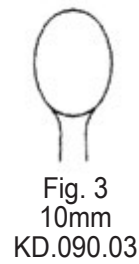
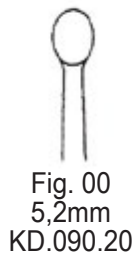
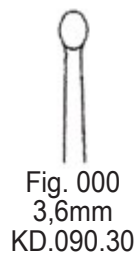

Syvert  
38cm

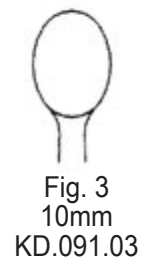
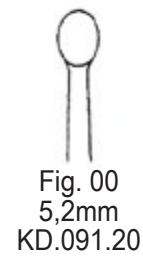
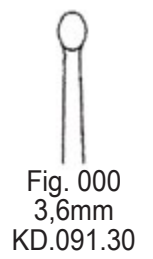





Syfert  
42cm

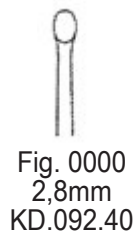

Fig. 0000  
2,8mm  
KD.092.40



Fig. 000  
3,6mm  
KD.092.30



MEDE Spezial  
41cm

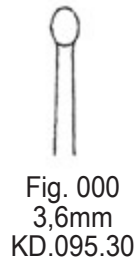

Fig. 000  
3,6mm  
KD.095.30

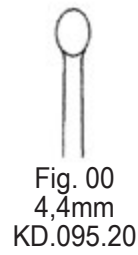

Fig. 00  
4,4mm  
KD.095.20

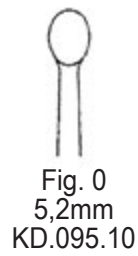

Fig. 0  
5,2mm  
KD.095.10



MEDE Spezial  
41cm

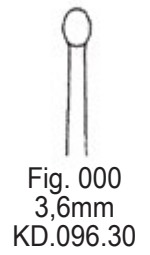

Fig. 000  
3,6mm  
KD.096.30

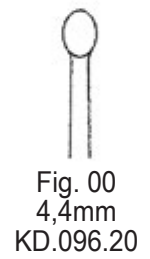

Fig. 00  
4,4mm  
KD.096.20

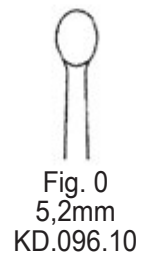

Fig. 0  
5,2mm  
KD.096.10

**SCHARFE LÖFFEL**  
**BONE CURETTES**

CUCHARILLAS CORTANTES  
CURETTES  
CURETTE TAGLIANTI

KD



27cm



Caspar  
22cm

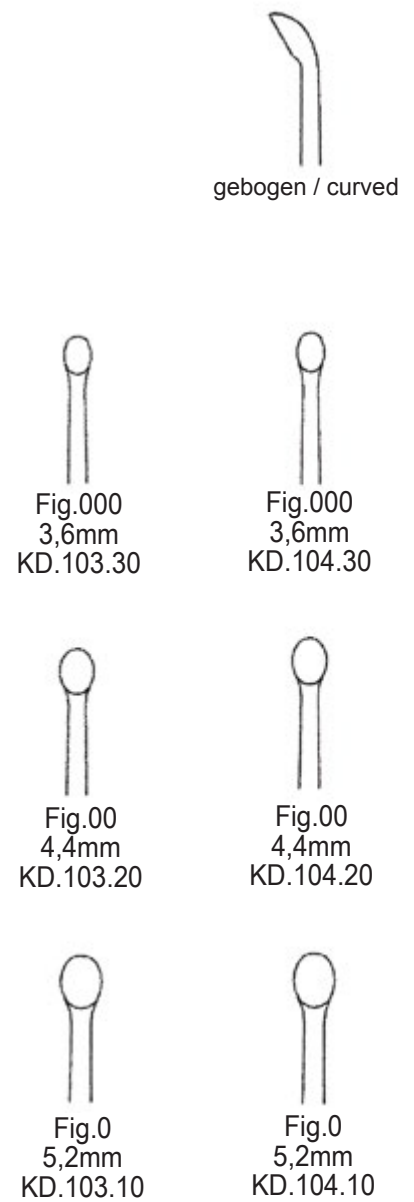



Schede  
 17cm

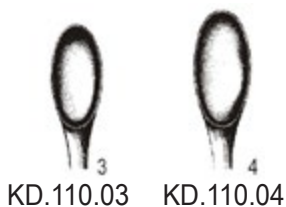
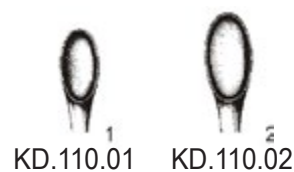

Bruns  
 16,5cm

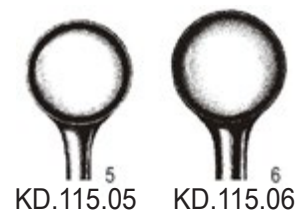
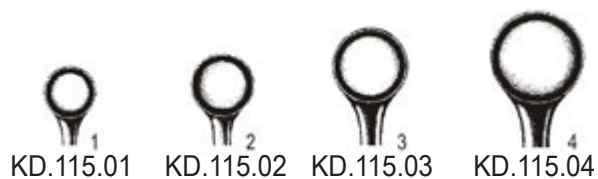

Volkmann  
 17cm

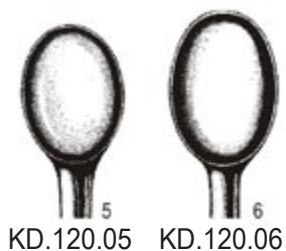

Spratt  
 16cm

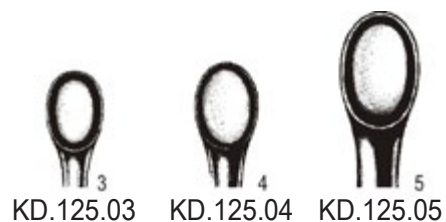
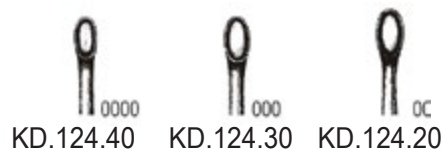

**HOHLMEISSELZANGEN**  
**BONE RONGEURS**

PINZAS-GUBIAS  
PINCES-GOUGES  
PINZE-SGORBIE

KE

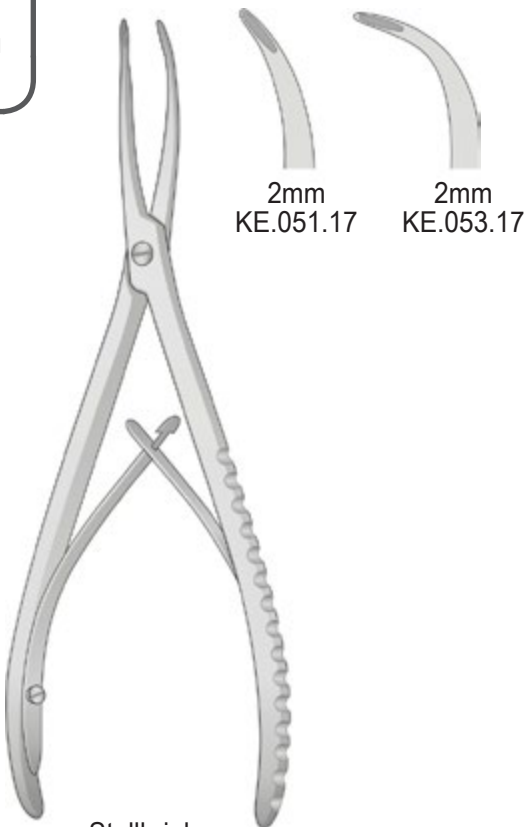

Stellbrink  
17cm



Friedmann  
15cm



Cleveland  
16cm  
KE.073.17



Hartmann  
18,5cm  
KE.085.18



Mead  
16cm  
KE.101.16



Mini-Friedmann  
12cm  
KE.061.12



Friedmann  
14cm  
KE.063.14

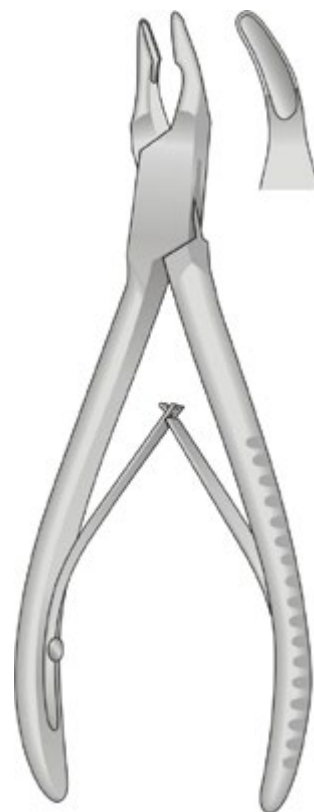

Blumenthal  
15,5cm  
KE.120.01



Cleveland  
14cm  
KE.071.14



Mead  
16,5cm  
KE.081.16



Janson  
18cm  
KE.108.18

**HOHLMEISSELZANGEN**  
**BONE RONGEURS**

PINZAS-GUBIAS  
PINCES-GOUGES  
PINZE-SGORBIE

KE



Luer  
17cm



KE.112.17



KE.113.17



Lempert  
16 + 19cm



KE.114.16  
KE.114.19

16cm  
19cm



KE.115.16  
KE.115.19

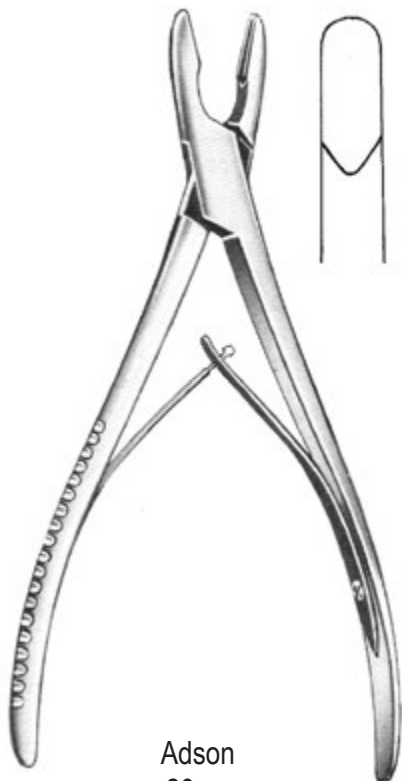

Adson  
20cm  
KE.124.20



Olivercrona  
20cm  
KE.127.20



Luer  
15cm



KE.135.15



KE.137.15



KE.139.15



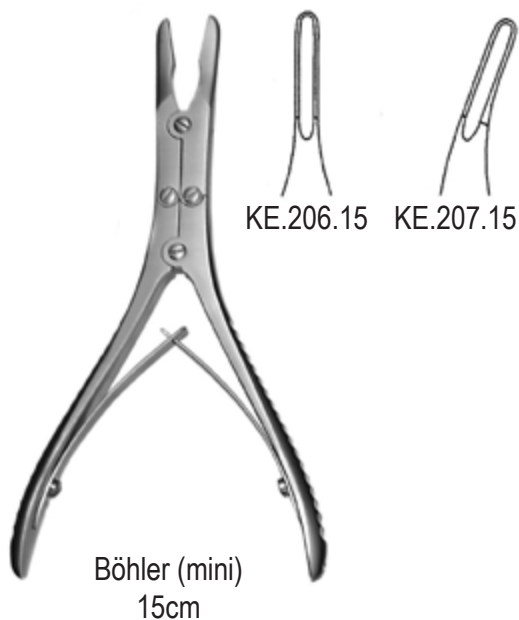

**HOHLMEISSELZANGEN**  
**BONE RONGEURS**

PINZAS-GUBIAS  
PINCES-GOUGES  
PINZE-SGORBIE

KE



Röttgen-Ruskin  
23cm  
KE.227.23



Stille-Luer  
22cm + 26cm

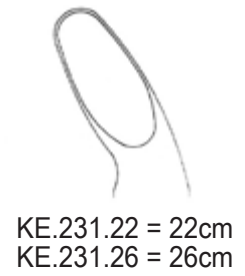
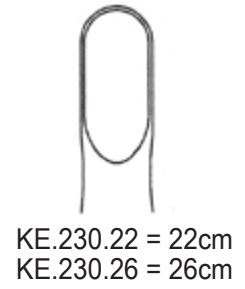

Stille  
23cm  
KE.240.23



Leksell  
25cm





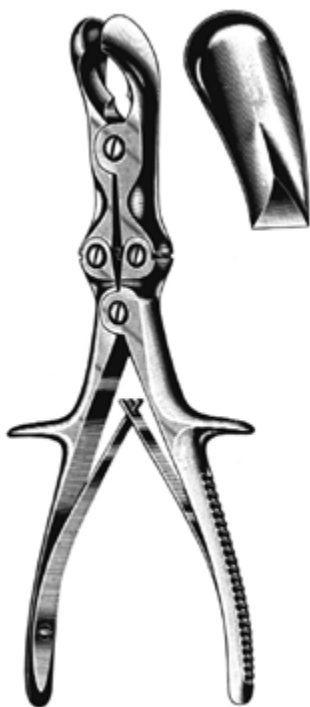

Semb  
22cm  
KE.245.22



Echlin  
23cm



KE.247.02 KE.247.03 KE.247.04



Frykhom  
23cm  
KE.251.23



KE.254.27



KE.255.27



Stille-Luer  
27cm

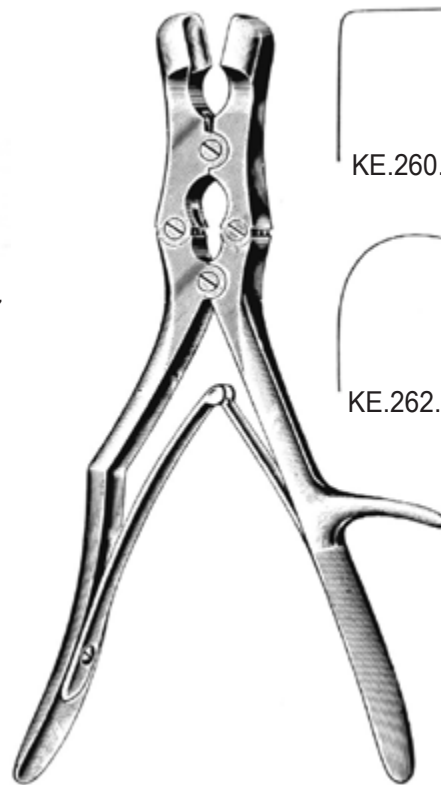

Sauerbruch  
30cm

KE.260.30

KE.262.30

**KNOCHENSPLITTERZANGEN**  
**BONE CUTTING FORCEPS**

PINZAS CORTANTES PARA HUESOS  
 PINCES COUPANTES À OS  
 CESCOIE PER OSSA

KE



Cottle-Kazanijan  
 19cm  
 KE.404.19

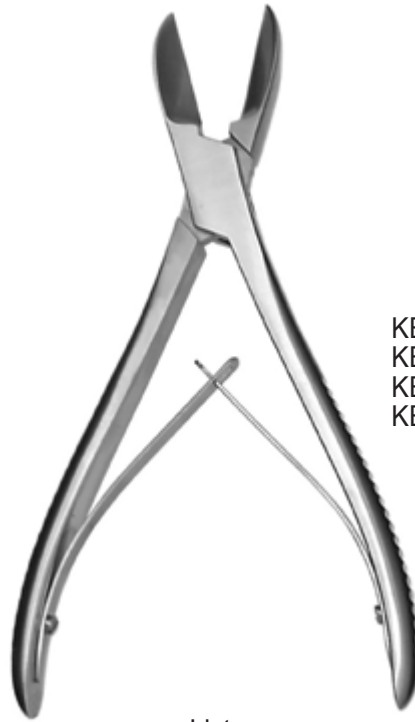

Liston



KE.410.14 = 14cm  
 KE.410.17 = 17cm  
 KE.410.19 = 19cm  
 KE.410.22 = 22cm

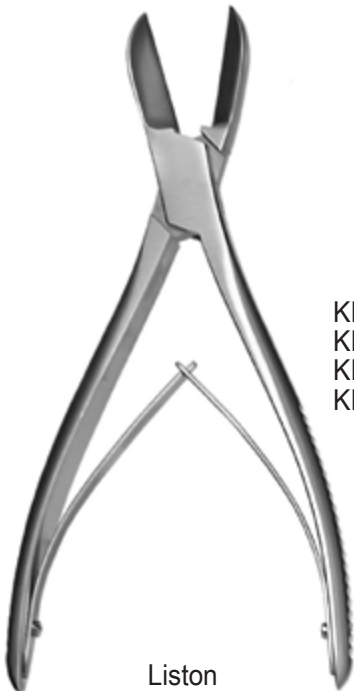

Liston



KE.411.14 = 14cm  
 KE.411.17 = 17cm  
 KE.411.19 = 19cm  
 KE.411.22 = 22cm



Littauer-Liston  
 16cm  
 KE.416.16





Knochenschere  
16cm  
KE.426.16



Knochenschere  
21,5cm  
KE.428.21

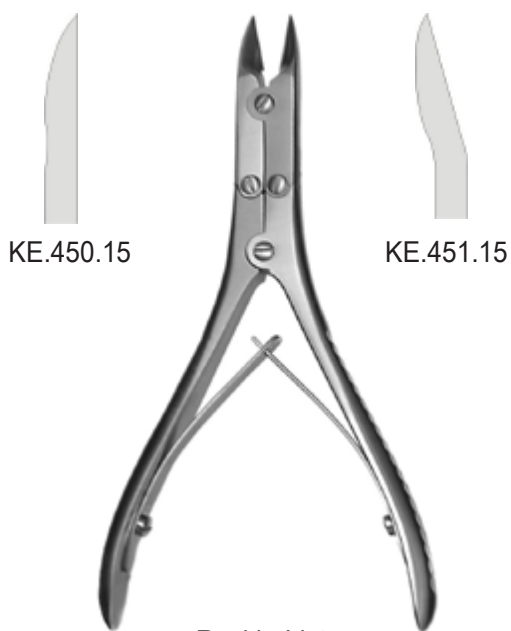

KE.450.15

KE.451.15

Ruskin-Liston  
15cm

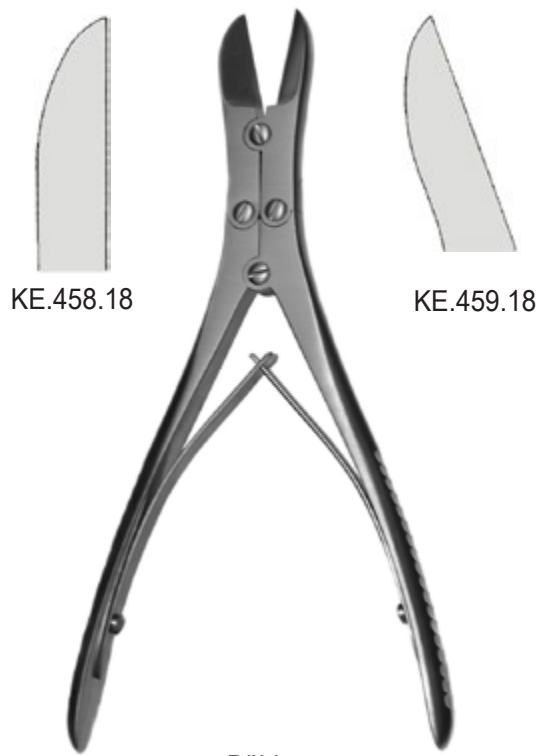

KE.458.18

KE.459.18

Böhler  
18cm

**KNOCHENSPLITTERZANGEN**  
**BONE CUTTING FORCEPS**

PINZAS CORTANTES PARA HUESOS  
PINCES COUPANTES À OS  
CESOIE PER OSSA

KE



MEDE-Kurz  
16,5cm  
KE.454.16



MEDE-Spezial  
18,5cm  
KE.458.19



Stille-Liston  
27cm  
KE.470.27



Stille-Liston  
27cm  
KE.474.27



Stille-Liston  
KE.475.23 = 23cm  
KE.475.27 = 27cm



Liston-Key  
27cm  
KE.480.27



Semb  
24cm  
KE.482.24

**KNOCHENHALTEZANGEN**  
**BONE HOLDING FORCEPS**

PINZAS PARA HUESOS  
 DAVIERS PORTE-OS  
 TENAGLIE PER OSSA

KF



Sequesterzange  
 20cm

KF.130.20

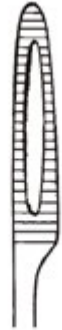

KF.131.20



Van Buren  
 23cm  
 KF.135.23

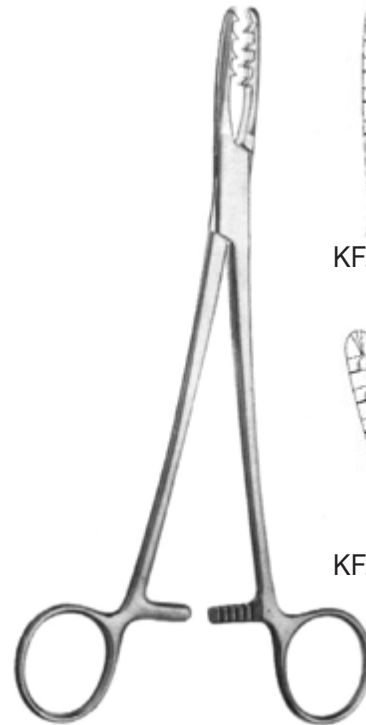

Bircher-Ganske  
 20cm

KF.140.20

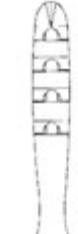

KF.141.20



Bircher-Ganske  
 20cm  
 KF.142.20



KF.149.19



KF.149.89

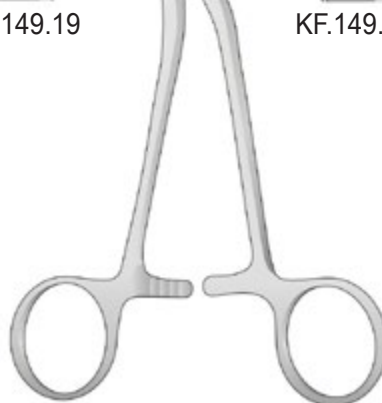

Dingmann  
 18,5cm

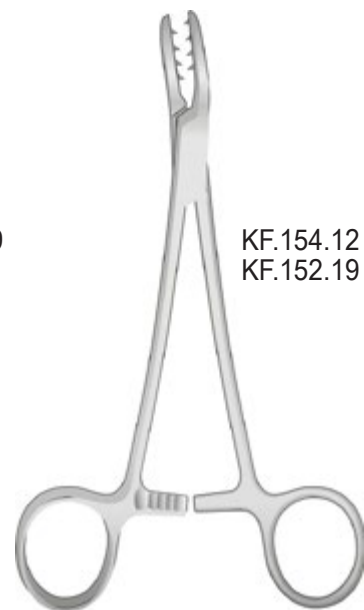

Martin

KF.154.12 = 12cm  
 KF.152.19 = 19cm



Knochenfaßzange  
14cm  
KF.145.14



Langenbeck Knochenfaßzange  
21cm  
KF.184.21



Repositionszange  
13,5cm  
KF.168.90



**KNOCHENHALTEZANGEN**  
**BONE HOLDING FORCEPS**

PINZAS PARA HUESOS  
DAVIERS PORTE-OS  
TENAGLIE PER OSSA

KF



16cm  
KF.162.16

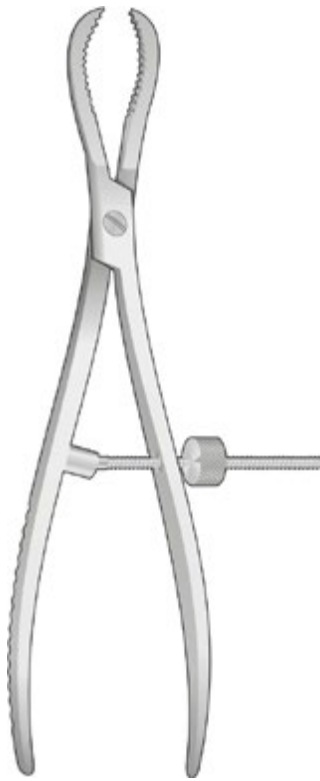

24cm  
KF.162.24



Article No.	Size
KF.168.09	9,0cm
KF.168.14	14,0cm

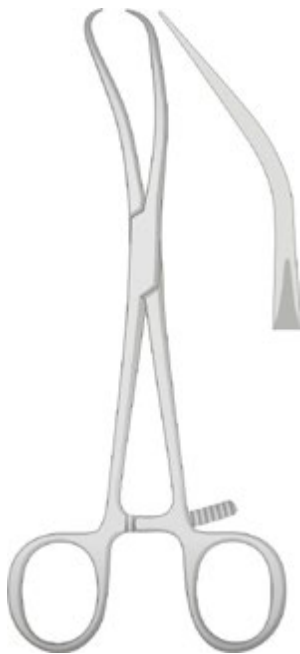

Reil

Article No.	Size
K F.169.17	17,0cm

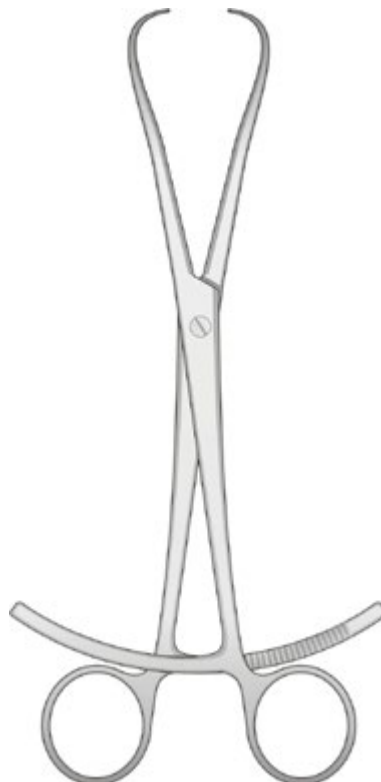

Repositionszange

Article No.	Size
KF.170.20	20,0cm



Patella

Article No.	Size
KF.172.18	18,5cm



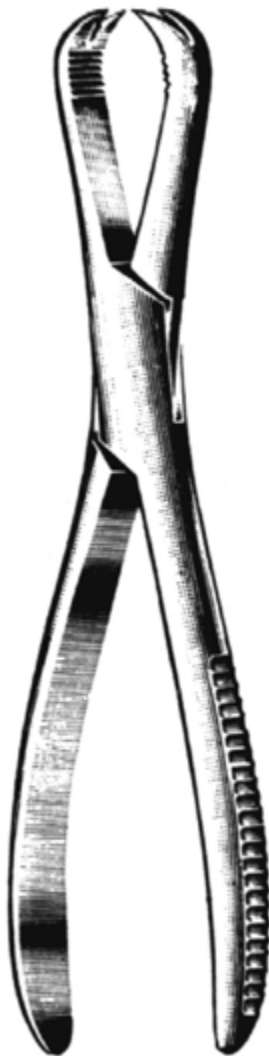

Langenbeck  
21cm  
KF.180.21

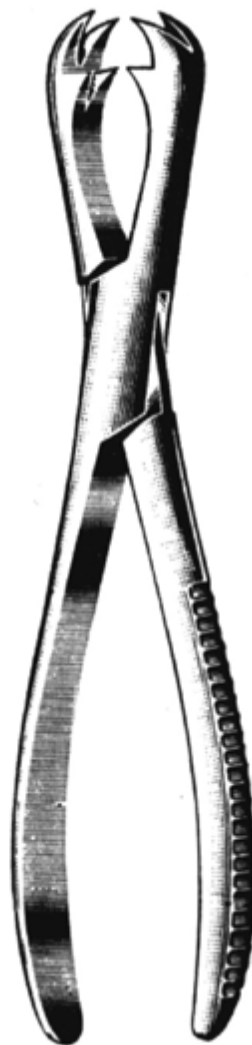

Fergusson  
21cm  
KF.182.21



20cm  
KF.186.20

**KNOCHENHALTEZANGEN**  
**BONE HOLDING FORCEPS**

PINZAS PARA HUESOS  
DAVIERS PORTE-OS  
TENAGLIE PER OSSA

KF

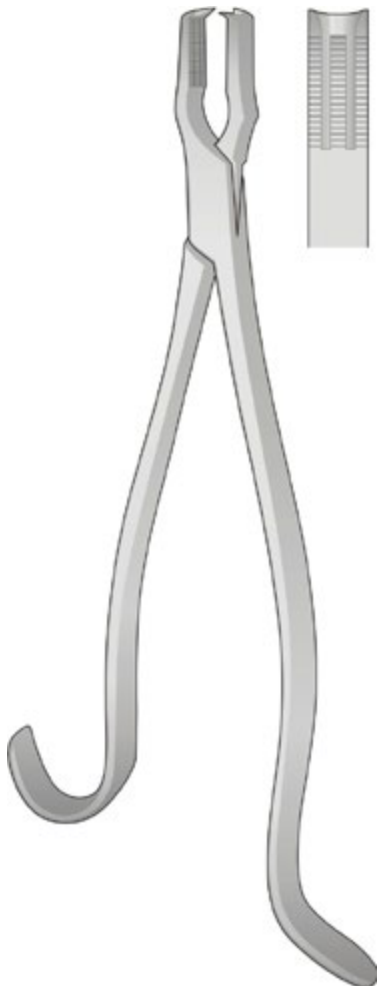

Kern  
KF.200.15 = 15cm  
KF.200.17 = 17cm  
KF.200.21 = 21cm

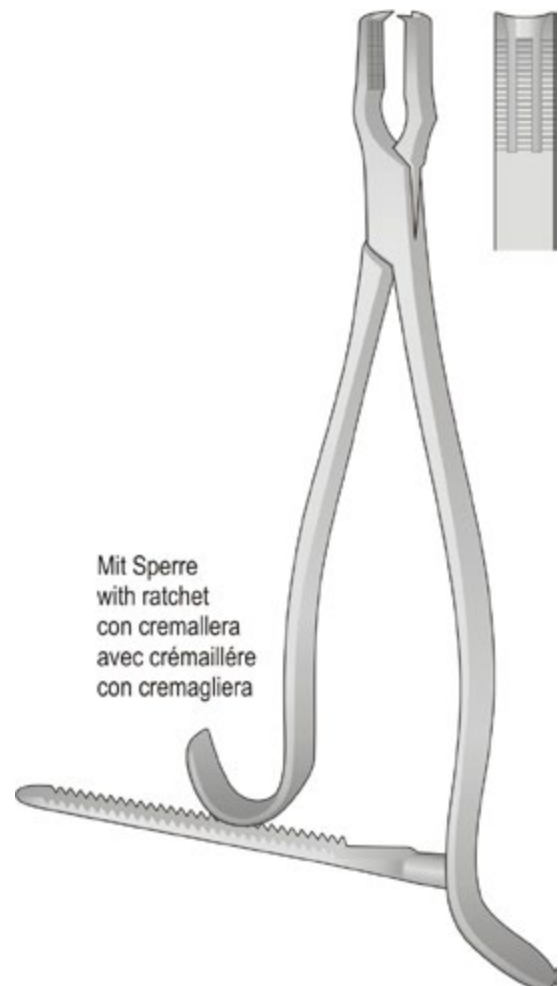

Mit Sperre  
with ratchet  
con cremallera  
avec crémaillère  
con cremagliera

Kern  
KF.202.15 = 15cm  
KF.202.17 = 17cm  
KF.202.21 = 21cm

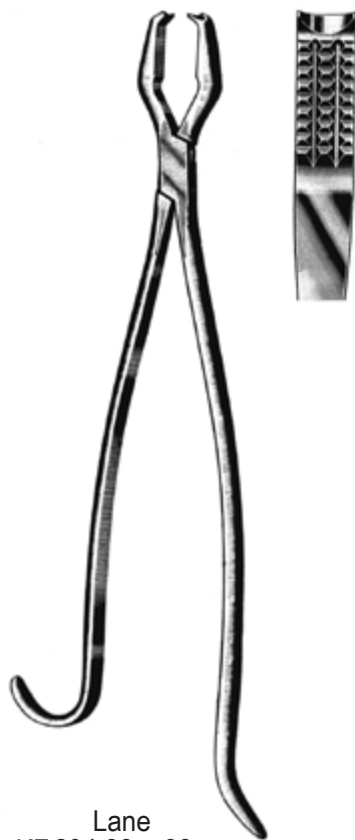

Lane  
KF.204.33 = 33cm  
KF.204.45 = 45cm



Lane  
KF.205.33 = 33cm  
KF.205.45 = 45cm



Semb  
19cm  
KF.210.19



Semb  
19cm  
KF.211.19

**KNOCHENHALTEZANGEN**  
**BONE HOLDING FORCEPS**

PINZAS PARA HUESOS  
DAVIERS PORTE-OS  
TENAGLIE PER OSSA

KF



Farabeuf  
KF.220.23 = 23cm  
KF.220.26 = 26cm



Farabeuf-Lambotte  
26cm  
KF.224.26



Maulteil beweglich  
movable jaw  
mandibula mobile  
mors mobile  
snodabile

Lambotte  
KF.228.22 = 22cm  
KF.228.27 = 27cm



Lambotte  
KF.230.22 = 22cm  
KF.230.26 = 26,5cm



Lambotte  
33cm  
KF.232.33



**KNOCHENHALTEZANGEN**  
**BONE HOLDING FORCEPS**

PINZAS PARA HUESOS  
DAVIERS PORTE-OS  
TENAGLIE PER OSSA

KF

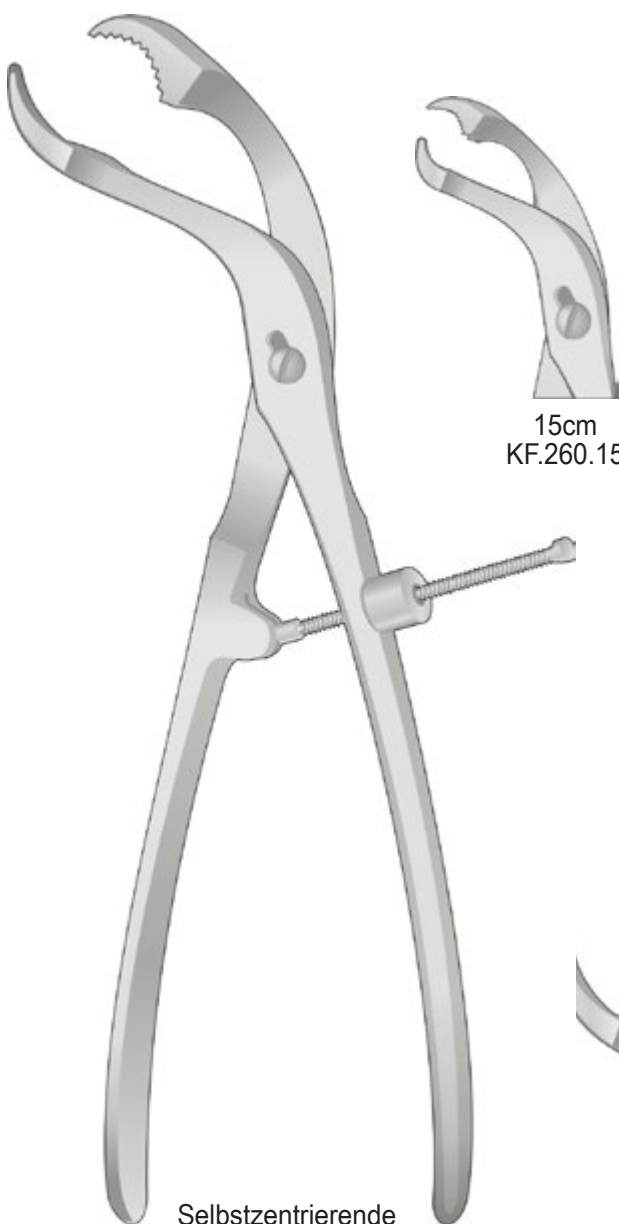

15cm  
KF.260.15



19cm  
KF.260.19



24cm  
KF.260.24



26cm  
KF.260.26



28cm  
KF.260.28

Selbstzentrierende  
Knochenhaltezeange  
mit Gewindesperre

Self-centering forceps  
with thread fixation

fórceps autocentrante con  
tope de fijación

á centrage automatique  
avec arrêt de filetage

autocentrante con blocco  
di filettatura



Verbrugge

Article No.	Size
KF.280.17	17,5cm



**KNOCHENHALTEZANGEN**  
**BONE HOLDING FORCEPS**

PINZAS PARA HUESOS  
 DAVIERS PORTE-OS  
 TENAGLIE PER OSSA

KF

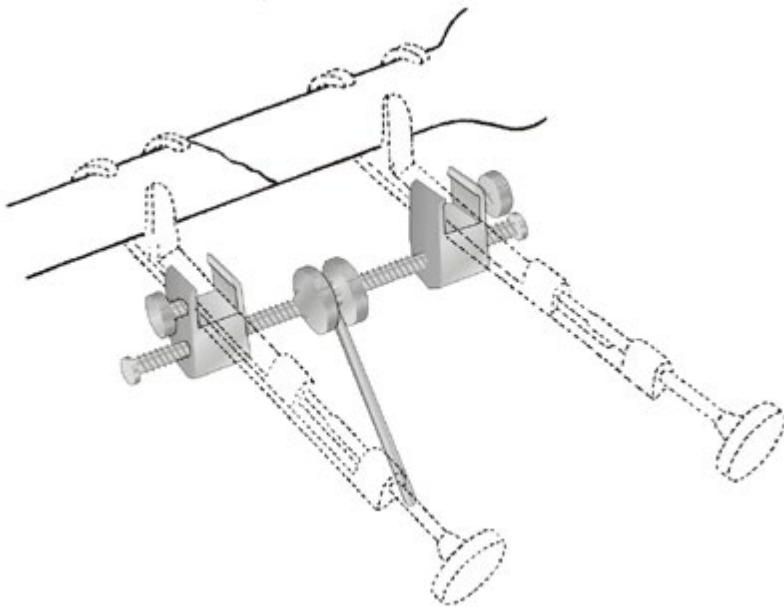

Gerster Distractionsklammer  
 KF.420.15  
 passend für Lowman Knochenhalteklammern



Lowman  
 KF.400.12 = 12cm  
 KF.400.18 = 18cm  
 KF.400.20 = 20cm



Knochenfaßzange  

Article No.	Size
KF.430.26	26,0cm





Schnellspanner  
Drehbarer Handgriff

Article No.	Size
KG.060.60	13,00



T-Griff  
Schnellspannfutter klein

Article No.	Size
KG.060.10	8,5

# HANDBOHRFUTTER DRILLING CHUCKS

MANGOS PARA CLAVOS  
MANDINS DE PERFORATION  
PEFORATORI A MANO MANDRINO

KG



Dreibackenfutter  
0,5-7,4mm u. Schlüssel

Article No.	Free passage
KG.060.92	Ø 7,4mm



T-Griff mit Dreibackenfutter  
und Schlüssel (0-6,0mm)

Article No.	Free passage
KG.060.50	Ø 6,0mm



Dreibackenfutter 0-6,0mm  
und Schlüssel

Article No.	Free passage
KG.060.91	Ø 6,0mm



T-Griff mit Handbohrfutter  
ergo

Article No.	Free passage
KG.065.01	Ø 4,2mm



Dreibackenfutter ergo  
klein

Article No.	Free passage
KG.065.81	Ø 4,2mm



T-Griff mit Handbohrfutter  
ergo

Article No.	Free passage
KG.065.03	Ø 5,3mm



Dreibackenfutter ergo  
groß

Article No.	Free passage
KG.065.83	Ø 5,3mm



Handbohrfutter ergo groß  
Spannkraftverriegelung

Article No.	Free passage
KG.065.10	Ø 5,3mm



Dreibackenfutter ergo  
groß Spannkraftverriegelung

Article No.	Free passage
KG.065.85	Ø 5,3mm



T-Griff Handbohrfutter ergo mit Spannkraftverriegelung

Article No.	Free passage
KG.065.20	Ø 5,3mm



Dreibackenfutter ergo groß

Article No.	Free passage
KG.065.86	Ø 5,3mm



Schlüssel für Jacobs Chuck KOM

Article No.
KG.060.96



Schlüssel für Jacobs Chuck K1M

Article No.
KG.060.97



Schlüssel

Article No.
KG.060.99



T-Griff alleine

Article No.	Size
KG.060.94	Schaft 45mm



T-Griff alleine

Article No.	Size
KG.060.95	Schaft 60mm

**REIBAHLEN**  
**REAMERS**

ESCARIADORES  
ALÈNES  
PERFORADORES A MANI

KG



14cm  
KG.200.14

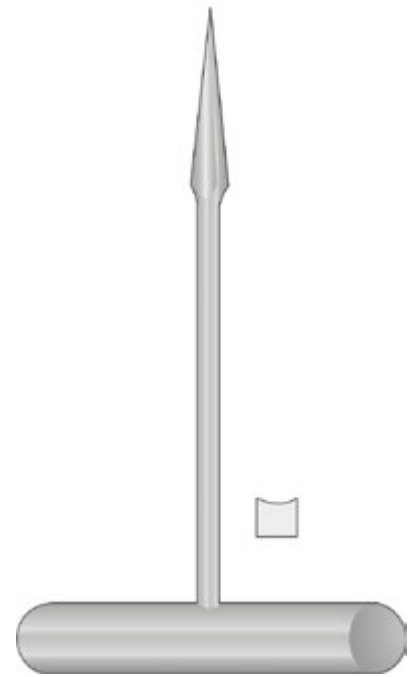

14cm  
KG.205.14



Perthes  
18cm  
KG.206.18



Perthes  
21cm  
KG.206.21

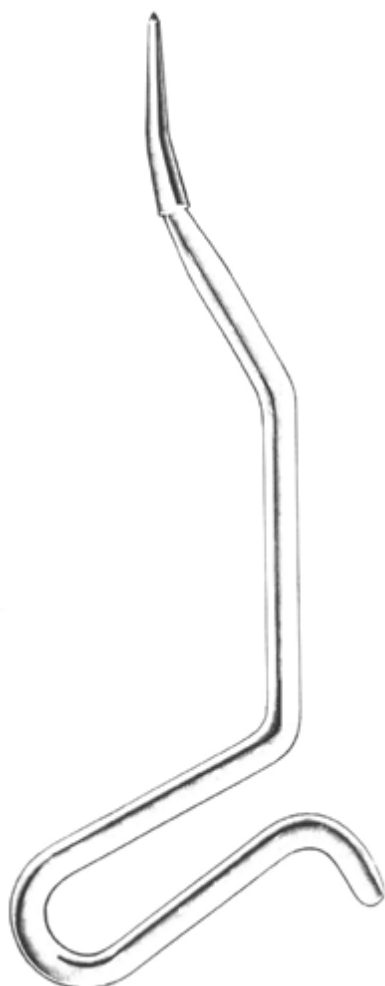

Vorbohrer  
KG.216.01



Ausziehaken  
Extractions-Hook  
KG.220.29 - 5mm | 29cm  
KG.220.37 - 5mm | 37cm  
KG.220.43 - 5mm | 43cm  
KG.220.51 - 5mm | 51cm

**SCHRAUBENDREHER**  
**SCREW DRIVER**

DESTORBILLADOR  
TOURNEVIS  
GIRAVITI

KG

Auch mit andern  
Griffen lieferbar.



25cm / 2,5mm  
KG.300.25



25cm / 3,5mm  
KG.300.35



25cm / 3,5mm  
KG.303.35



25cm / 3,5mm  
KG.304.35

Auch mit andern  
Griffen lieferbar.



Lane Schraubenzieher  
Ferrozell

Article No.	Size
KG.304.17	17,0cm

Lane Schraubenzieher  
Ferrozell

Article No.	Size
KG.304.25	25,0cm

Schraubenzieher  
Ferrozell Kreuzschlitz

Article No.	Size
KG.306.25	25,0cm

Phillips Schraubenzieher  
Ferrozell Kreuzschlitz

Article No.	Size
KG.308.25	25,0cm

# SCHRAUBENDREHER SCREW DRIVER

DESTORBILLADOR  
TOURNEVIS  
GIRAVITI

KG

2,5 mm



Schraubenhalter

Article No.	Size
KG.315.01	2,5mm



Schraubendreher mit  
Schraubenhalter

Article No.	Size
KG.320.19	19,5 cm



Torx Schraubendreher  
T9

Article No.	Size
KG.323.19	17,5 cm



Imbusschlüssel 18x100

Article No.	Size
KG.340.20	2,0mm

Imbusschlüssel 18x112

Article No.	Size
KG.340.25	2,5mm



Messbereich 40mm  
kleine Schrauben



KG.400.01

Messbereich 60mm  
schmale Schrauben



KG.400.04

Messbereich 110mm  
große Schrauben



KG.400.06

Messbereich 110mm  
große Schrauben  
+ Schutzhülse



KG.400.08

**DRAHTSPANNZANGEN**  
**WIRE TWISTER**

TENSORES DE ALAMBRE  
PINCES À TORSADER LE FIL  
PINZA TORCIFILI

KH



Mayo-Haberisser

- 15,0cm  
KH.200.15
- 18,0cm  
KH.200.18
- 20,0cm  
KH.200.20



Mayo-Haberisser

- 13,0cm  
KH.201.13
- 15,0cm  
KH.201.15
- 18,0cm  
KH.201.18
- 20,0cm  
KH.201.20



Berry

- 18,0cm  
KH.202.18
- 20,0cm  
KH.202.20
- 22,0cm  
KH.202.22



Flachzange - kräftiges Modell

Article No.	Size
KH.226.17	18,5cm



Kombizange  
mit Drahtschneider

Flachzange - kräftiges Modell

Article No.	Size
KH.226.18	18,0cm



Mit Hartmetall-  
einsätzen

*With Tungsten  
Carbid inserts*

Avec mors en métal dur  
Con puntas de metal duro  
Con punte in metallo duro

HM Flachzange 18,0cm

Article No.	Size
KH.240.01	2mm
KH.240.02	4mm
KH.240.06	6mm

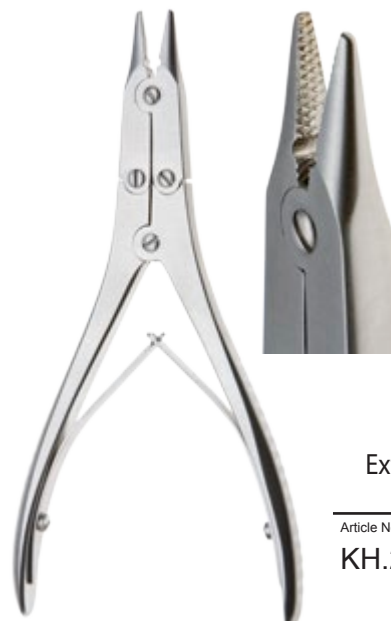

Extensionszange für  
Bohrdrähte

Article No.	Size
KH.241.14	14,5cm

**FLACHZANGEN**  
**FLAT NOSE PLIERS**

ALICATES PLANOS  
PINCES PLATES  
TENAGILE PLATTE

**KH**



Extensionszange für  
Bohrdrähte mit V-Rille

Article No.	Size
KH.241.24H	14,5cm



Extensionszange für  
Bohrdrähte 14,5cm

Article No.	Size
KH.241.24	4mm



HM Extensionszange  
für Bohrdrähte

Article No.	Size
KH.241.44	14,5cm



Flachzange Übersetzt  
18,0cm

Article No.	Size
KH.244.02	2mm
KH.244.04	4mm
KH.244.06	6mm



Flachzange Übersetzt

Article No.	Size
KH.244.18	18,0cm



Flachzange Übersetzt  
für 1,5mm Platten

Article No.	Size
KH.244.66	18,0cm

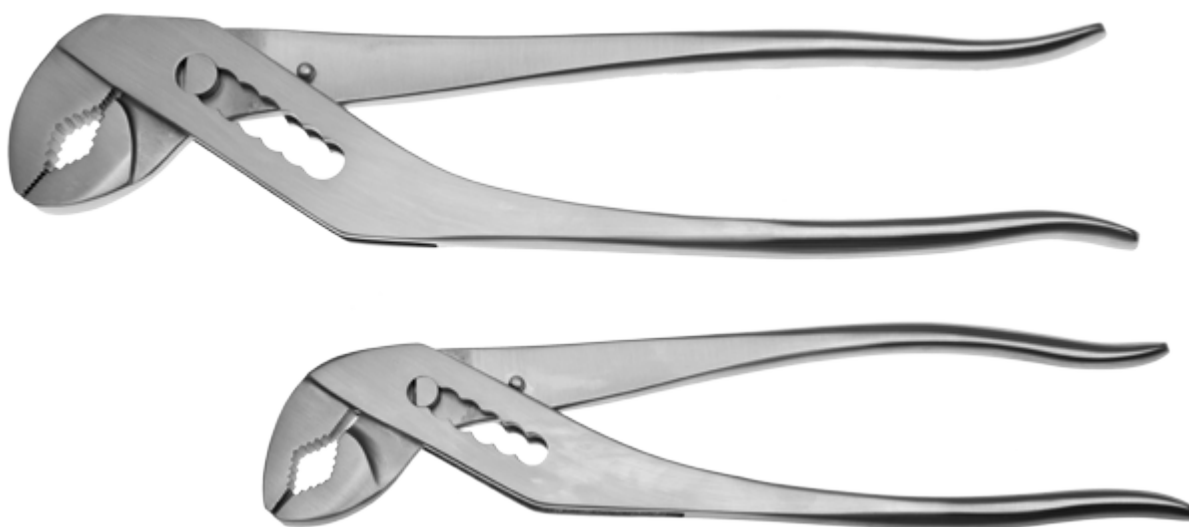

Universalzange verstellbar  
(Rohrzange)

Article No.	Size
KH.255.17	16,5cm
KH.255.24	24,0cm
KH.255.30	30,0cm

**FLACHZANGEN**  
**FLAT NOSE PLIERS**

ALICATES PLANOS  
PINCES PLATES  
TENAGILE PLATTE

KH



Flachzange

Article No.	Size
KH.260.14	14,0cm



Marburg

Article No.	Size
KH.262.01	14,0cm



KH.262.02

KH.262.03

Mit Hartmetalleinlage  
with TC inserts

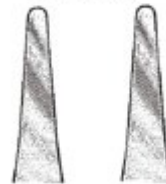

KH.262.06



gerieft mit  
Blutrille

Flachzange

Article No.	Size
KH.262.14	14,0cm



Needle nose  
plier  
3mm tip

Flachzange

Article No.	Size
KH.262.16	16,0cm



Feststellzange  
(Tonnenzange)

Article No.	Size
KH.262.18	18,0cm
KH.262.20	20,0cm
KH.262.24	24,0cm

ALICATES PLANOS  
 PINCES PLATES  
 TENAGILE PLATTE

## FLACHZANGEN FLAT NOSE PLIERS

KH



5mm

Eingesetztes Maul-  
 teil mit Blutrille

Flachzange

Article No.	Size
KH.262.46	14,0cm



Flachzange einstellbar  
*Flat pliers movable*

Article No.	Size
KH.264.20	20.0cm



TC

Mit Hartmetall-  
 einsätzen

*With Tungsten  
 Carbide inserts*

Avec mors en métal dur  
 Con puntas de metal duro  
 Con punte in metallo duro

Für Draht bis 1,2mm hart  
 und 2,0mm weich

Flachzange mit Drahtschneider

Article No.	Size
KH.265.22	22,0cm



**FLACHZANGEN**  
**FLAT NOSE PLIERS**

ALICATES PLANOS  
PINCES PLATES  
TENAGILE PLATTE

**KH**



Hackstock Flachzange

Article No.	Size
KH.266.16	16,0cm



Mit Schneider  
With cutter

Flachzange

Article No.	Size
KH.267.16	16,5cm



Langes Maulteil  
mit Schneider  
Long Jaw parts  
with cutter

Flachzange

Article No.	Size
KH.267.17	17,5cm



Sehr langes Maulteil  
mit Schneider  
Very long Jaw parts  
with cutter

Flachzange

Article No.	Size
KH.267.20	20,0cm





Mit Hartmetalleinsätzen

*With Tungsten Carbide inserts*

Avec mors en métal dur  
Con puntas de metal duro  
Con punte in metallo duro

Drahtziehzange

Article No.	Size
KH.268.14	14,0cm



Spitzmaulzange

Article No.	Size
KH.272.24	24,0cm
KH.272.30	30,0cm

# DRAHTFASSZANGEN WIRE HOLDING FORCEPS

FÓRCEPS PARA EXTRAER ALAMBRE  
PINCES PLATES  
TENAGLIE PIATTE

KH



Mit Hartmetall-  
einsätzen

*With Tungsten  
Carbid inserts*

Avec mors en métal dur  
Con puntas de metal duro  
Con punte in metallo duro



Extensionszange HM

Article No.	Size
KH.241.44	14,0cm



# EXTRAKTIONSZANGEN FÜR BOHRDRÄHTE WIRE EXTRACTION



Flachzange - gerieft Backen

Article No.	Size
KH.270.01	17,0cm



Flachzange - Längs- u. Querrillen

Article No.	Size
KH.270.02	17,0cm



Mit Hartmetalleinsätzen

With Tungsten Carbide inserts

11

Flachzange mit HM

Article No.	Size
KH.275.19	19,0cm

Flachzange

Article No.	Size
KH.274.19	19,0cm



Extraktionszange

Article No.	Size
KH.280.13	13,0cm



Extraktionszange

Article No.	Size
KH.280.18	18,0cm

**DRAHTSCHNEIDEZANGEN**  
**WIRE CUTTERS**

FÓRCEPS PARA CORTAR ALAMBRE  
PINCESÀ COUPER LE FIL  
TRONCHESI PER FILI METALLICI

KH



1:1

Diamant Kopfschneider

Article No.	Size
KH.310.16	16,0cm

FÓRCEPS PARA CORTAR ALAMBRE  
 PINCESÀ COUPER LE FIL  
 TRONCHESI PER FILI METALLICI

## HM DRAHTSCHNEIDEZANGEN TC WIRE CUTTERS

KH



HM Drahtkneifzange

Article No.	Size
KH.312.18	18,0cm
KH.312.20	20,0cm

Mit Hartmetall-  
einsätzen

*With Tungsten  
Carbid inserts*

Avec mors en métal dur  
 Con puntas de metal duro  
 Con punte in metallo duro



HM Drahtschneidezange 1,7mm

Article No.	Size
KH.315.16	16,0cm
KH.315.18	18,0cm



Drahtschneidezange 2,2mm

Article No.	Size
KH.315.23	23,0cm

**HM DRAHTSCHNEIDEZANGEN**  
**TC WIRE CUTTERS**

FÓRCEPS PARA CORTAR ALAMBRE  
 PINCESÀ COUPER LE FIL  
 TRONCHESI PER FILI METALLICI

**KH**



**Drahtschneidezange 1,5mm**

Article No.	Size
KH.316.18	18,0cm

Mit Hartmetall-  
einsätzen

*With Tungsten  
Carbid inserts*

Avec mors en métal dur  
 Con puntas de metal duro  
 Con punte in metallo duro



**Seitenschneider 2,2mm**

Article No.	Size
KH.316.23	23,0cm



**Kopfschneider 2,2mm**

Article No.	Size
KH.318.22	22,0cm

FÓRCEPS PARA CORTAR ALAMBRE  
PINCESÀ COUPER LE FIL  
TRONCHESI PER FILI METALLICI

## HM DRAHTSCHNEIDEZANGEN TC WIRE CUTTERS

KH



Mit Hartmetall-  
einsätzen

*With Tungsten  
Carbid inserts*

Avec mors en métal dur  
Con puntas de metal duro  
Con punte in metallo duro

Plattenschneidezange

Article No.	Size
KH.322.24	24,0cm



Kunststoffbacken  
zum halten  
durchtrennter  
Plattenteile.

Golpla Plattenschneider  
mit Kunststoffhaltebacken

Article No.	Size
KH.325.25	25,0cm

# HM DRAHTSCHNEIDEZANGEN TC WIRE CUTTERS

FÓRCEPS PARA CORTAR ALAMBRE  
PINCESÀ COUPER LE FIL  
TRONCHESI PER FILI METALLICI

KH

Mit Hartmetall-  
einsätzen

*With Tungsten  
Carbid inserts*

Avec mors en métal dur  
Con puntas de metal duro  
Con punte in metallo duro



Kopfschneider 1,5mm

Article No.	Size
KH.320.15	15,0cm



Kopf- und Seitenschneider 1,7mm

Article No.	Size
KH.340.18	18,0cm



FÓRCEPS PARA CORTAR ALAMBRE  
 PINCESÀ COUPER LE FIL  
 TRONCHESI PER FILI METALLICI

## HM DRAHTSCHNEIDEZANGEN TC WIRE CUTTERS



Waldsachs  
 Klammer- und Bügelbiege

Article No.	Size
KH.258.16	16,0cm



Weicher Draht  
 bis 0,6mm  
 Harter draht  
 bis 0,3mm

Angle  
 Drahtschneidezange HM

Article No.	Size
KH.263.13	13,0cm



Drahtschneidezange  
 Ø 0,7mm

Article No.	Size
KH.372.12	12,5cm



KH.372.14



Drahtschneidezange mittel

Article No.	Size
KH.374.13	13,0cm



Drahtschneidezange 1,0mm

Article No.	Size
KH.376.15	15,0cm



Drahtschneidezange HM 1,0mm

Article No.	Size
KH.377.15	15,0cm



Kopfschneider

Article No.	Size
KH.378.14	14,5cm

**BOLZENSCHNEIDER**  
**PIN CUTTERS / WIRE CUTTERS**

FÓRCEPS PARA CORTAR ALAMBRE Y AGUJAS  
 PINCES À COUPER LE FIL  
 TENAGLIE TAGLIAFILI

KH



Bolzenschneider 6mm

Article No.	Size
KH.350.47	47,0cm



Ersatzbacken  
 KH.350.90

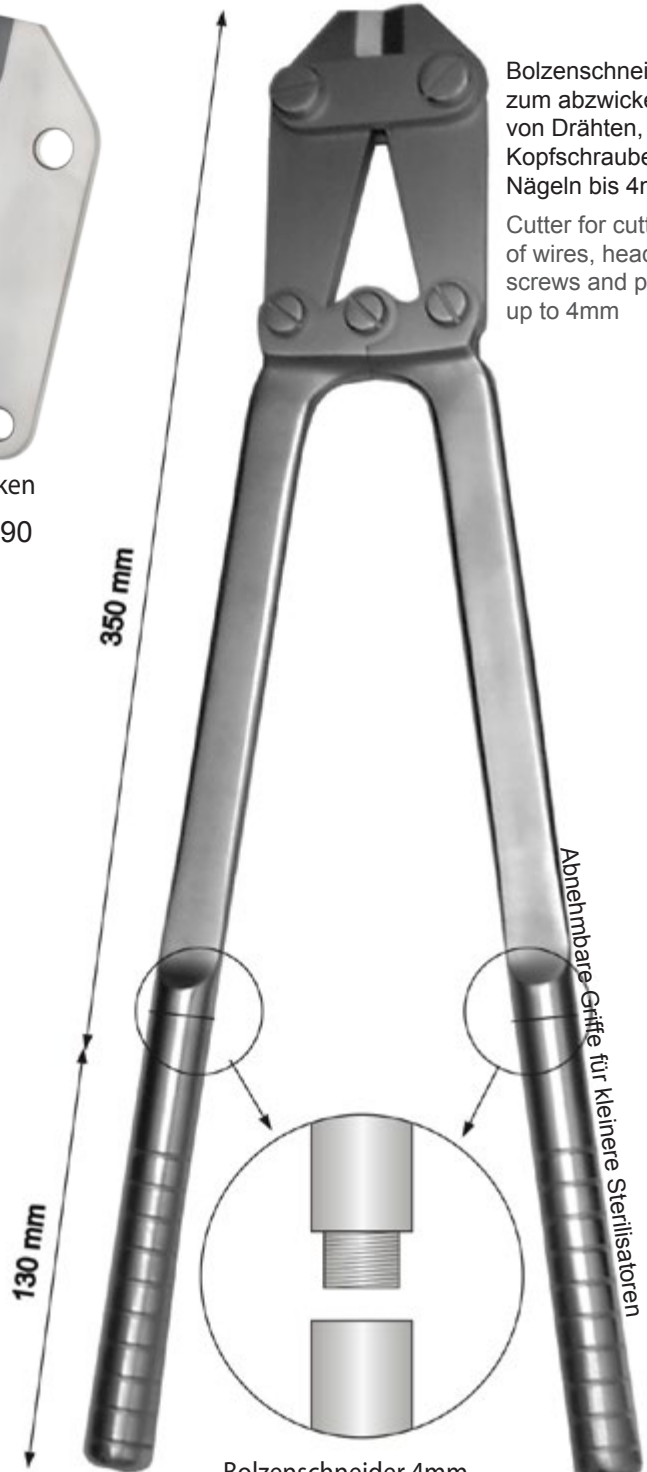

Bolzenschneider zum abwickeln von Drähten, Kopfschrauben & Nägeln bis 4mm  
 Cutter for cutting of wires, head screws and pins up to 4mm

Abnehmbare Griffe für kleinere Sterilisatoren

Bolzenschneider 4mm mit abnehmbaren Griffen

Article No.	Size
KH.352.48	48,0cm

Kopfschneider zum  
abzwicken von Drähten,  
Kopfschrauben und  
Nägeln bis 5mm

Cutter for cutting of  
wires, head screws and  
pins up to 5mm



Ersatzbacken  
KH.354.99

Bolzenschneider 5mm  
Kopfschneidend

Article No.	Size
KH.354.38	38,0cm

**BOLZENSCHNEIDER**  
**PIN CUTTERS / WIRE CUTTERS**

FÓRCEPS PARA CORTAR ALAMBRE Y AGUJAS  
 PINCES À COUPER LE FIL  
 TENAGLIE TAGLIAFIL

KH

Bolzenschneider zum Schneiden von Kirschner Drähten, Steinman Nägel und Schrauben bis 6mm  
 Cutter for cutting of Kirschner wires, Steinman Pins and Screws up to 6mm diam.



Bolzenschneider 6mm

Article No.	Size
KH.356.45	45,0mm



Ersatzbacken  
 KH.356.99



Bolzenschneider 6mm

Article No.	Size
KH.356.56	56,0mm

FÓRCEPS PARA CORTAR ALAMBRE  
PINCESÀ COUPER LE FIL  
TRONCHESI PER FILI METALLICI

## KRAMPONZANGEN UNIVERSAL KRAMPON FORCEPS

KH

Für harten Draht bis 1mm  
For hard wire 1mm  
Para alambres duro 1mm  
Per filio duro 1mm



Kramponzange

Article No.	Size
KH.360.15	15,0cm



Kramponzange flach

Article No.	Size
KH.362.15	15,0cm

# DRAHTSCHEREN WIRE CUTTING SCISSORS

CIZALLAS PARA CORTAR ALAMBRE  
CISEAUX POUR FIL  
FORBICI PER FILI

KH

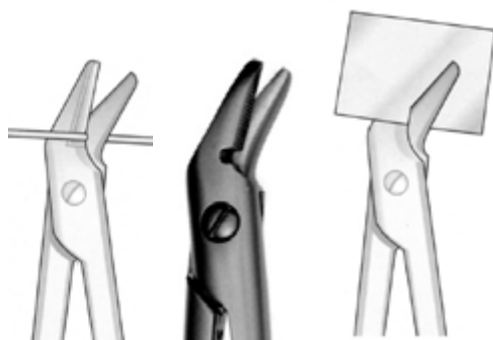

Universal Drahtschere  
Eine Seite gezahnt

Article No.	Size
AB.547.12	12,0cm

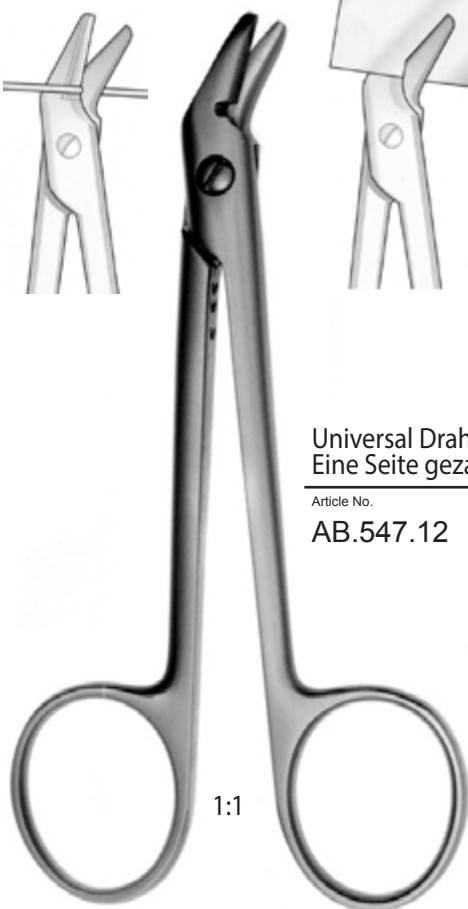

1:1

TC

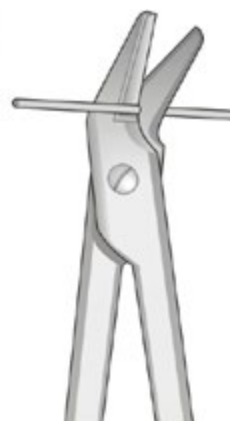

Universal Drahtschere  
HM

Article No.	Size
AB.865.12	12,0cm

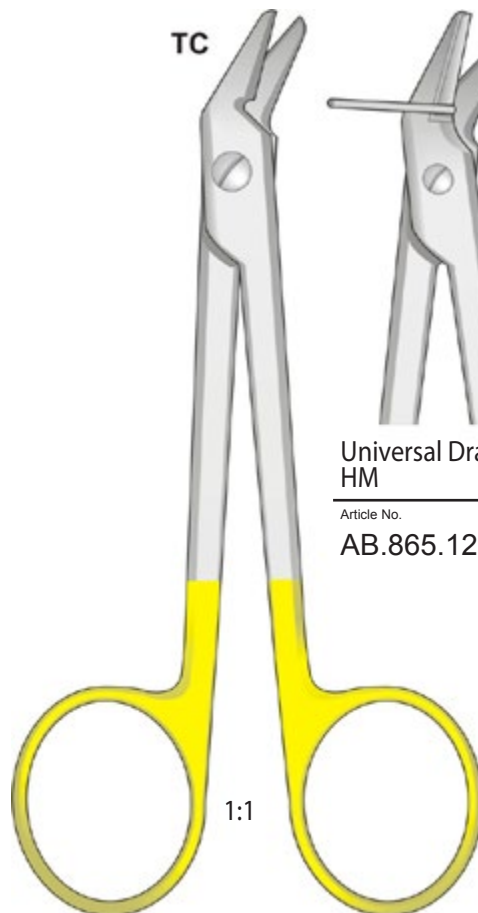

1:1



Smith Drahtschere HM  
Eine Seite gezahnt

Article No.	Size
KH.392.16	16,0cm



Smith Drahtschere HM  
Mit Drahtkerbe

Article No.	Size
KH.394.16	16,0cm



Weich  
Soft  
blado  
melléable  
malleabile

Ring mit 10m  
coils of 10m  
en rolls de 10m  
en rouleaux de 10m

Ring mit 10m  
coils of 10m  
en rolls de 10m  
en rouleaux de 10m

Ring mit 5m  
coils of 5m  
en rolls de 5m  
en rouleaux de 5m

**Knochendraht 1.4441**

Article No.	Size
KH.600.02	0,2mm
KH.600.03	0,3mm
KH.600.04	0,4mm
KH.600.05	0,5mm
KH.600.06	0,6mm
KH.600.07	0,7mm
KH.600.08	0,8mm
KH.600.09	0,9mm
KH.600.10	1,0mm
KH.600.12	1,2mm
KH.600.15	1,5mm
KH.600.18	1,8mm
KH.600.20	2,0mm

**Knochendraht REINTITAN**

Article No.	Size
KH.600.58	0,8mm
KH.600.60	1,0mm
KH.600.62	1,2mm
KH.600.65	1,5mm

**Knochendraht REINTITAN**

Article No.	Size
KH.605.58	0,8mm
KH.605.60	1,0mm
KH.605.62	1,2mm
KH.605.65	1,5mm



# DRÄHTE MESSLEHREN WIRES GAUGING TOOLS

KH

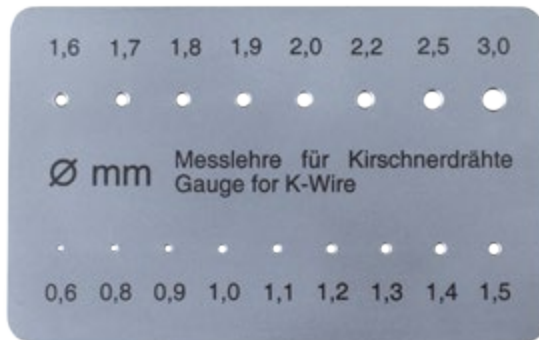

Meßlehre für Kirschnerdrähte

Article No.	Size
KH.600.99	0,6 - 3,0mm



Stahlmeßstab

Article No.	Size
KH.601.15	15,0cm
KH.601.20	20,0cm
KH.601.30	30,0cm
KH.601.40	40,0cm
KH.601.50	50,0cm



Stahlmeßstab

Article No.	Size
KH.602.20	20,0cm
KH.602.30	30,0cm
KH.602.40	40,0cm
KH.602.50	50,0cm



**BIEGEINSTRUMENT**  
**BENDING INSTRUMENT**

KH



Biegeinstrument

Article No.	Size
KH.590.12	12,0cm



Biegeinstrument  
für Kirschnerdrähte

Article No.	Size
KH.592.30	30,0cm

**DRAHTSÄGEN GRIFF**  
**WIRE SAWS HANDLE**

**KH**



Hakengriff  
für Drahtsägen

Article No.

KH.605.01



Demel



30,5cm  
KH.700.01



28,5cm  
KH.700.02



24cm  
KH.700.24

27cm  
KH.700.27



24,0cm  
KH.702.24

27,0cm  
KH.702.27



# DRAHTUMFÜHRUNGSNADELN CERCLAGE INSTRUMENTS

AIGUILLES PASS-FILS  
AGHI PASSAFILLI

KH



Drahtumführung Links

Article No.	Size
KH.703.22L	22,0cm



Drahtumführung Links

Article No.	Size
KH.703.24L	24,5cm



45mm  
KH.704.45



70mm  
KH.704.70

Drahtumführung

Article No.	Size
	23,5cm



Drahtumführung 45mm

Article No.	Size
KH.705.45	18,0cm



Demel  
27cm  
KH.718.28



Loute  
22cm  
KH.720.21

# SCHRÄNKHEBEL

## BENDING IRONS FOR BONE PLATES

INSTRUMENTS POUR COURBER LES PLAQUES  
 INSTRUMENTOS PARA DOBLAR PLACAS  
 STRUMENTI PER PIEGARE PLACCHE

KJ

6mm

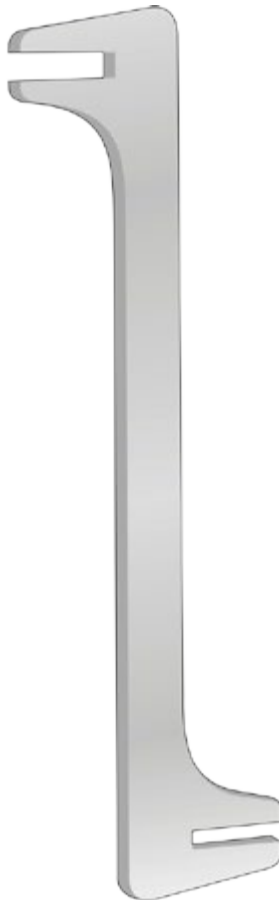

4mm

Biege und Schränkseisen

Article No.	Size
KJ.205.25	24cm

2,7mm  
3,5mm



Schränkhebel

Article No.	Size
KJ.206.14	14cm

3,5mm  
2,7mm



Schränkhebel

Article No.	Size
KJ.207.14	14cm

1,8mm



Schränkhebel

Article No.	Size
KJ.209.12	12cm

## PLATTENBIEGEINSTRUMENTE FORCEPS FOR PLATTES-BENDING PRESS

KJ



Für Platten bis 1,6mm,  
2,0mm oder 3,0mm

For Plattes up to  
1,6mm, 2,0mm or  
3,0mm



### Plattenbiegezange

Article No.	Size
KJ.600.22	20,0cm
KJ.600.24	22,0cm
KJ.600.25	25,0cm

Biegeapparat zum Biegen von Knochenplatten  
bis 6mm Dicke. Der untere Backen ist heraus-  
nehmbar. Komplett aus rostfreiem Stahl gefertigt.



### Biegeapparat

Article No.	Size
KJ.610.00	bis 6mm



**STERILISATION & AUFBEWAHRUNG**  
**STERILIZATION AND CONSERVATION**

ESTERILIZACIÓN Y CONSERVACIÓN  
 STERILISATION ET CONSERVATION  
 SCODELLE ROTONDE, RECIPIENTI CILINDRICI

MH



Standgefäß

Article No.	Size
MH.300.08	50x130 mm
MH.300.14	75x100 mm
MH.300.21	100x150 mm
MH.300.28	100x200 mm
MH.300.75	175x100 mm



Auch mit Deckel  
erhältlich



Standzylinder

Article No.	Size
MH.302.10	50x100 mm
MH.302.13	50x130 mm
MH.302.17	50x175 mm
MH.302.40	75x100 mm
MH.302.43	75x130 mm
MH.302.47	75x175 mm



Nierenschale

Article No.	Size
MH.600.17	170mm
MH.600.20	200mm
MH.600.25	250mm
MH.600.27	275mm

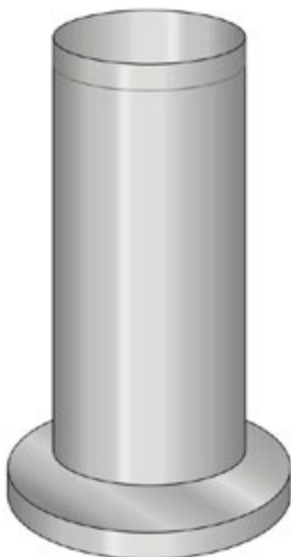

Gefäß mit festem Fuß

Article No.	Size
MH.303.10	50x100 mm
MH.303.13	50x130 mm
MH.303.17	50x175 mm



Laborschale

Article No.	Size
MH.660.04	40x19mm
MH.660.06	60x30mm
MH.660.08	85x41mm
MH.660.11	115x56mm
MH.660.12	130x55mm
MH.660.14	150x65mm

Mit Ausguss  
with spout



Lösungsschale

Article No.	Size
MH.650.04	4,5cm / ca. 0,03L
MH.650.06	6,0cm / ca. 0,10L
MH.650.08	8,0cm / ca. 0,15L
MH.650.10	10cm / ca. 0,25L
MH.650.12	12cm / ca. 0,50L
MH.650.16	16cm / ca. 1,0 L
MH.650.20	20cm / ca. 2,0 L
MH.650.24	24cm / ca. 4,0 L





Messbecher

Article No.	Size
MH.620.05	0,5L
MH.620.10	1,0L



Lösungsschale  
mit breitem Rand

Article No.	Size
MH.665.08	8,0x3,5cm
MH.665.09	9,0x5,5cm
MH.665.10	10x6,5cm
MH.665.12	12x7,0cm



Watte - und Tupferbehälter

Article No.	Size
MH.670.09	Ø8,5cm H:8,5cm
MH.670.10	Ø10cm H: 10cm
MH.670.12	Ø12cm H: 12cm
MH.670.15	Ø15cm H: 15cm



Stechbecken mit Deckel

Article No.	Size
MK.102.31	31cm



Stechbecken ohne Deckel

Article No.	Size
MK.105.24	32x24cm
MK.105.29	37x29cm



Article No.	For	Article No.	For	Article No.	For
MK.106.20	Female	MK.106.15	Urinal	MK.106.10	Male

# NADEL STERILISIERKÄSTCHEN

## STERILIZATION AND CONSERVATION

ESTERILIZACIÓN Y CONSERVACIÓN  
BOITES POUR STÉRILISER DES AIGUILLES  
SCATOLE PER STERILIZZARE AGHI

MH



Nadeldose komplett

Article No.	Size
MH.810.65	rund



Nadeldose  
Innenteil alleine

Article No.	Size
MH.811.65	rund



Nadelkästchen

Article No.	Size
MH.800.50	50x25x4,5mm
MH.800.65	65x42x8,0mm
MH.800.75	75x25x4,5mm



Nadelkästchen gelocht

Article No.	Size
MH.802.50	50x25x4,5mm
MH.802.65	65x42x8,0mm
MH.802.75	75x25x4,5mm



Nadelkästchen

Article No.	Size
MH.818.15	150x95x13mm

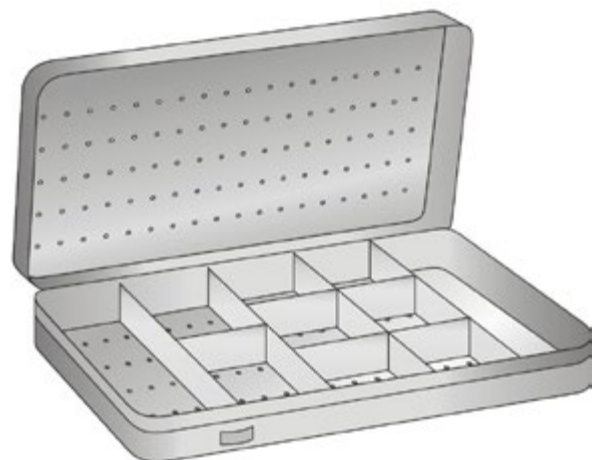

Nadelkästchen

Article No.	Size
MH.815.20	215x125x17mm

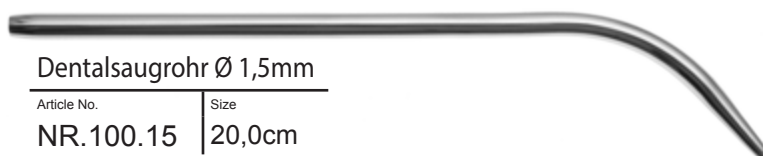

Dentalsaugrohr Ø 1,5mm

Article No.	Size
NR.100.15	20,0cm



Dentalsaugrohr Ø 3mm

Article No.	Size
NR.100.30	20,0cm



Dentalsaugrohr Ø 5mm

Article No.	Size
NR.100.50	20,0cm

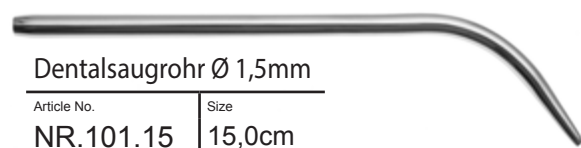

Dentalsaugrohr Ø 1,5mm

Article No.	Size
NR.101.15	15,0cm



Dentalsaugrohr Ø 3mm

Article No.	Size
NR.101.30	15,0cm



Dentalsaugrohr Ø 5mm

Article No.	Size
NR.101.50	15,0cm

MEDE Technik GmbH  
Rudolf-Diesel-Str. 13  
78576 Emmingen  
Germany

Tel: +49 (0)7465 893  
Fax: +49 (0)7465 2262

[info@mede.de](mailto:info@mede.de)  
[www.mede.de](http://www.mede.de)

---

**DIN EN ISO 13485 zertifiziert / certified.**

---

Nachdruck, auch auszugsweise, nicht gestattet.  
Reprinting even partially is not allowed.